

Video Transmitter

Operating Instructions _____ **EN**

Mode d'emploi _____ **F**

Manual de instrucciones _____ **ES**

RSE-500
RSE-400

Owner's Record

The model and the serial numbers are located at the rear. Record the serial number in the space provided below. Refer to these numbers whenever you call upon your Sony dealer regarding this product.

Model No. RSE-500/400 Serial No. _____

WARNING

To prevent fire or shock hazard, do not expose the unit to rain or moisture.

To avoid electrical shock, do not open the cabinet. Refer servicing to qualified personnel only.

For the customers in the USA

This equipment has been tested and found to comply with the limits for a Class B digital device, pursuant to Part 15 of the FCC Rules. These limits are designed to provide reasonable protection against harmful interference in a residential installation. This equipment generates, uses and can radiate radio frequency energy and, if not installed and used in accordance with the instructions, may cause harmful interference to radio communications. However, there is no guarantee that interference will not occur in a particular installation. If this equipment does cause harmful interference to radio or television reception, which can be determined by turning the equipment off and on, the user is encouraged to try to correct the interference by one or more of the following measures:

- Reorient or relocate the receiving antenna.
- Increase the separation between the equipment and receiver.
- Connect the equipment into an outlet on a circuit different from that to which the receiver is connected.
- Consult the dealer or an experienced radio/TV technician for help

You are cautioned that any changes or modifications not expressly approved in this manual could void your authority to operate this equipment.

The shielded interface cable recommended in this manual must be used with this equipment in order to comply with the limits for a digital device pursuant to Subpart B of Part 15 of FCC Rules.

IMPORTANT INSTRUCTION TO USERS

1. This equipment complies with Part 68 of the FCC Rules. On the rear of this equipment is a label that contains, among other information, the FCC registration number for this equipment. If requested, this information must be provided to the telephone company.
2. If the terminal equipment, RSE-500 or RSE-400, causes harm to the telephone network, the telephone company will notify you in advance that temporary discontinuance of service may be required. But if advance notice is not practical, the telephone company will notify the customer as soon as possible. Also, you will be advised of your right to file a complaint with the FCC if you believe it is necessary.
3. The telephone company may make changes in its facilities, equipment, operations or procedures that could affect the operation of the equipment. If this happens the telephone company will provide advance notice in order for you to make necessary modifications to maintain uninterrupted service.
4. If trouble is experienced with this equipment, RSE-500 or RSE-400, for repair or warranty information, please contact Sony Business Information Center ☎1-800-686-7669*. If the equipment is causing harm to the telephone network, the telephone company may request that you disconnect the equipment until the problem is resolved.
5. The equipment cannot be used on public coin phone service provided by the telephone company. Connection to party line service is subject to state tariffs.

* In the USA only. For the customers in Canada and Latin America, please contact your Sony dealer.

For the customers in Canada

NOTICE: The Industry Canada label identifies certified equipment. This certification means that the equipment meets certain telecommunications network protective, operational and safety requirements as prescribed in the appropriate Terminal Equipment Technical Requirements document (s). The Department does not guarantee the equipment will operate to the user's satisfaction.

Before installing this equipment, users should ensure that it is permissible to be connected to the facilities of the local telecommunications company. The equipment must also be installed using an acceptable method of connection. The customer should be aware that compliance with the above conditions may not prevent degradation of service in some situations.

Repairs to certified equipment should be coordinated by a representative designated by the supplier. Any repairs or alterations made by the user to this equipment, or equipment malfunctions, may give the telecommunications company cause to request the user to disconnect the equipment.

Users should ensure for their own protection that the electrical ground connections of the power utility, telephone lines and internal metallic water pipe system, if present, are connected together. This precaution may be particularly important in rural areas.

Caution: Users should not attempt to make such connections themselves, but should contact the appropriate electric inspection authority, or electrician, as appropriate.

This manual focuses on using ISDN lines to conduct a video transmission, but it also covers non-ISDN lines. If you use ISDN lines, consult your Sony dealer for more information.

- The ISDN service may not be available in some areas.

Table of Contents

Precautions	6 (EN)
On Safety	6 (EN)
On Handling	6 (EN)

Chapter 1 Preparation

Features	1-1 (EN)
Configuration and Connections	1-3 (EN)
System Configuration	1-3 (EN)
Connections for the Central Site	1-4 (EN)
Connections for the Terminal Site	1-5 (EN)
Preparing the Remote Commander (Only for RSE-500)	1-6 (EN)
Inserting the Batteries	1-6 (EN)
Turning the Video Transmitter On and Off	1-6 (EN)
Turning the Video Transmitter On ...	1-6 (EN)
Turning the Video Transmitter Off ...	1-6 (EN)
Menus	1-7 (EN)
Operating the Menu	1-7 (EN)
Operating From a Computer	1-7 (EN)
Items in the Main Menu	1-8 (EN)

Chapter 2 Setup Using the SETTING Menu

About the SETTING Menu	2-1 (EN)
Items in the SETTING Menu	2-1 (EN)
Selecting an Item in the SETTING Menu	2-2 (EN)
Registering the Local Site Information	2-3 (EN)
Naming the Video Transmitter (ID Name)	2-3 (EN)
Naming the Video Transmitter (Site Name)	2-3 (EN)
Registering the Telephone Number and Subaddress	2-3 (EN)
Setting the Communication Mode	2-5 (EN)
Setting the Password	2-6 (EN)
Setting the Date and Time	2-6 (EN)

Setting the Answering Mode	2-7 (EN)
Basic Setting	2-7 (EN)
Adjusting the Line (Headset) Audio Level and the Microphone Input Level	2-7 (EN)
Selecting the Line (Headset) Volume	2-8 (EN)
Selecting the Microphone Input Level	2-8 (EN)
Selecting the Picture Quality	2-8 (EN)
Other Settings	2-9 (EN)
Inset Window Setting	2-10 (EN)
Selecting the Position of the Inset Window	2-10 (EN)
Port Setting	2-10 (EN)
Setting Up the ALARM IN Port	2-10 (EN)
Setting Up the RELAY OUT Port ..	2-11 (EN)
Setting Up the CAMERA CONTROL Port	2-11 (EN)
Setting Up the COMPUTER Port ...	2-11 (EN)
Setting Up the TABLET Port	2-12 (EN)
Setting Up the USER DATA Port ..	2-13 (EN)
Registering the Number of Cameras	2-13 (EN)
Registering the Number of Cameras Connected to the Video Transmitter	2-13 (EN)
Switching Pictures Automatically	2-14 (EN)
Setting the Time When the Pictures are Switched	2-14 (EN)
Disconnecting From the Line Automatically/ Turning to the Standby Mode Automatically	2-14 (EN)
Setting the Time When the Unit Disconnects From the Line or Turning to the Standby Mode	2-14 (EN)
Registering Called Parties	2-15 (EN)
Registering Your Called Party Information	2-15 (EN)
Registering Called Parties When an Alarm Signal Is Input	2-16 (EN)
Registering Your Called Party Information	2-16 (EN)

Registering Calling Parties with Permission to Be Connected 2-17 (EN)

- Registering Your Calling Party Information 2-17 (EN)
- Checking the Calling Party or Called Party Number..... 2-18 (EN)

Diagnosing the System 2-18 (EN)

- Setting the Loop Back and Debugging 2-18 (EN)
- Setting a Different Telephone Number for B2-channel for Maintenance 2-19 (EN)
- Diagnosing the Hardware 2-19 (EN)

Checking the ISDN Interface 2-21 (EN)

- Checking the BRI interface 2-21 (EN)
- Generating the INFO 1 Signal for Testing Layer 1 2-21 (EN)
- Looping Back the Primitive 2-21 (EN)

Chapter 3 Operation**Starting Communication 3-1 (EN)**

- Connecting to a Remote Site 3-1 (EN)
- Making the Line Busy Temporarily . 3-3 (EN)

Ending Communication 3-3 (EN)

- Disconnecting the Line 3-3 (EN)

Changing the Audio Level and Microphone Input Level 3-4 (EN)

- Changing the Headset and Line Volume of the Local Site 3-4 (EN)
- Changing the Headset and Line Volume of the Remote Site 3-4 (EN)
- Changing the Input Level of the Microphone of the Local Site 3-4 (EN)
- Changing the Input Level of the Microphone of the Remote Site 3-4 (EN)

Selecting the Picture 3-5 (EN)

- Switching the Pictures 3-5 (EN)
- Stopping the Camera Auto Scan Temporarily 3-5 (EN)

Adjusting the Picture 3-6 (EN)

- Operating the Camera 3-6 (EN)
- Changing the Quality of the Picture Sent from a Remote Site 3-6 (EN)

Changing the Screen Setting 3-7 (EN)

- Changing the Position of the Inset Window (Picture-in-Picture)..... 3-7 (EN)
- Selecting the Information to Display on the Monitor..... 3-7 (EN)

Setting Ports 3-8 (EN)

- Checking the Alarm Signals and Log File of the ALARM IN Port 3-8 (EN)
- Setting the Bit Value of the RELAY OUT Port 3-9 (EN)

Chapter 4 Tablet Operation**Preparing the Tablet 4-1 (EN)**

- Connecting the Tablet 4-1 (EN)
- Pasting the Menu Sheet on the Tablet..... 4-2 (EN)
- Operating Menus From the Tablet 4-2 (EN)

Tablet Icons 4-2 (EN)**Appendix****Location and Function of Controls A-1 (EN)**

- Video Transmitter A-1 (EN)
- Remote Commander (RM-R500) (Supplied With RSE-500 Only)..... A-4 (EN)

Transmitting Data A-5 (EN)

- Connecting a Device to the USER DATA Port A-5 (EN)
- Data Transmission Format A-5 (EN)

Troubleshooting A-6 (EN)**Specifications A-8 (EN)**

- Video Transmitter A-8 (EN)
- Pin Assignment A-9 (EN)

Glossary A-12 (EN)**Index A-13 (EN)**

Precautions

On Safety

Power supply

- Before operating the Video Transmitter, make sure the operating voltage of the unit is identical with that of your local power supply. The Remote Commander operates on two size AA (LR6) alkaline batteries.
- Do not unnaturally bend or crimp power cords, and do not place heavy objects on them. Damage to the cords may result in fire or electric shock.
- To remove a power cord from an AC outlet, pull on the plug. (Do not pull on the cord.)

Do not disassemble the unit

Do not open or disassemble the cabinet of the unit. Electric shock may result if you touch the inside of the cabinet.

Do not put foreign objects into the unit

Avoid having metallic or flammable object, liquid, or foreign matters fall into the cabinets of the unit. Otherwise a malfunction may result.

In case of trouble

In case of trouble such as smoke, odd smell, or noise, turn off all units of the system. Disconnect all the power cords and connecting cords. Then contact the place of purchase or an authorized Sony representative.

Telephone

- Avoid using a telephone (other than a cordless type) during an electrical storm. There may be a remote risk of electric shock from lightning.
- Do not use the telephone in the vicinity of a gas leak to report the leak.

On Handling

Installation/storage

Do not expose the system to:

- near water, for example, near a bath tub, wash bowl, kitchen sink or laundry tub, in a wet basement or near a swimming pool.
- extremely low or high temperatures.
- damp or dusty room.
- strong vibration.
- devices which generate strong magnetic fields.
- devices (such as radios or TVs) which transmit strong radio waves.
- noisy place.

Cleaning

Wipe the cabinet and panel with a dry, soft cloth. If the stain is serious, slightly moisten the cloth with mild detergent. Afterward, use a dry cloth to wipe it. Do not use solvents such as thinner, benzine, alcohol, as they may damage the finish of the cabinet.

Preparation

Features

The Video Transmitter can send and receive voice, pictures and control data via ISDN.

Conventional remote monitoring systems provide only still images. The Sony Video Transmitter provides moving pictures for real-time and precise monitoring. The Video Transmitter system is perfect for the requirements of the distribution and service industries demanding monitoring capabilities.

The system requires only one ISDN line for voice, pictures and control data

High quality images using H.261 compression technology, voice and control data can be sent or received simultaneously via one ISDN line. The ISDN modular jack can be connected directly to the Video Transmitter.

	Picture		Voice		Control data
	Send	Receive	Send	Receive	Send/Receive
RSE-500	●	●	●	●	●
RSE-400	●	—	●	●	●

●: possible —: impossible

Relay control and remote diagnostics

From the central site, you can operate a device (e. g., turning on lights or opening/closing doors) at a terminal site or you can monitor voice at a terminal site.

From the central site, you can diagnose a terminal site and identify the location of malfunctions or errors, enabling quick and efficient recovery.

Automatic data transmission upon detection of alarm signal

Up to 10 remote sites can be registered in one alarm port. When an alarm signal is detected, data is automatically transmitted to the registered telephone numbers.

Automatic camera selection upon detection of alarm signal

Up to 8 alarm signals can be input into one ALARM IN port. When an alarm signal is input, the system switches to the picture related to the port number which the alarm signal is input.

Features

Up to 64 remote sites can be registered

Up to 64 remote sites can be registered on one Video Transmitter, allowing for a large-scale remote monitoring system.

On-line picture quality adjustment (only for RSE-500)

While watching the picture from a remote site, you can change the picture quality (3 levels) to suit your needs.

Can be added to your existing system

You can easily install the Video Transmitter in an existing system for an enhanced monitoring system.

Password security

You can set a password to secure against unauthorized connection.

RS-232C interface

You can connect a computer to the Video Transmitter via RS-232C interface. Controlling the Video Transmitter from the computer enables easy and effective monitoring.

Configuration and Connections

The basic system configuration of the Video Transmitter is shown below.

In normal configuration, it consists of the central and terminal sites. The terminal sites are monitored by the central site.

RSE-400 is used only as a terminal site.

RSE-500 can be used as either a central site or a terminal site.

System Configuration

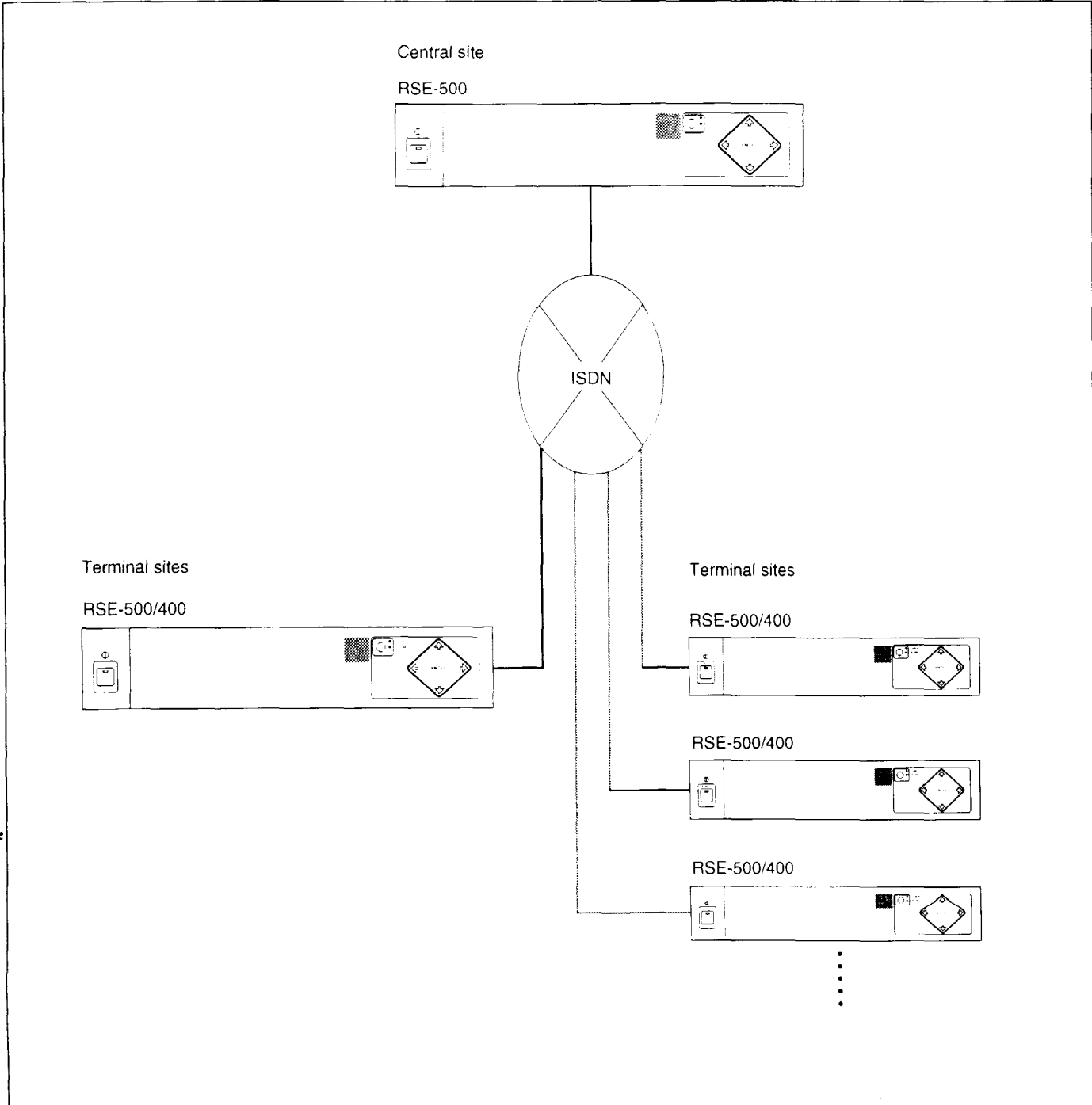

Configuration and Connections

Connections for the Central Site

The basic connections for the central site are shown below. (The illustration below is RSE-500.)

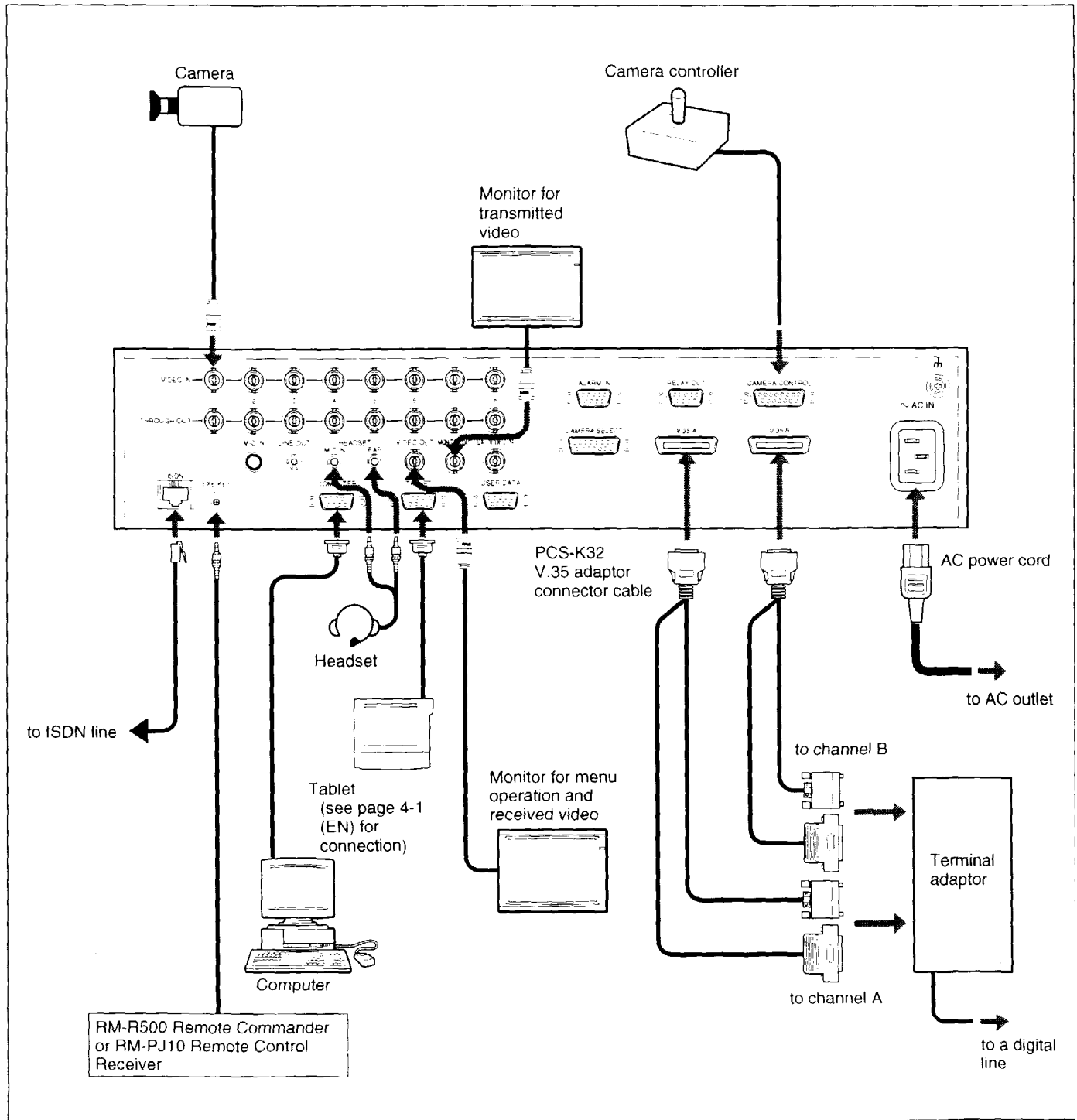

Note

If your headset jack does not match the Video Transmitter jack, use a plug adaptor (not supplied).

Connections for the Terminal Site

The basic connections for the terminal site are shown below. (The illustration below is RSE-500.)

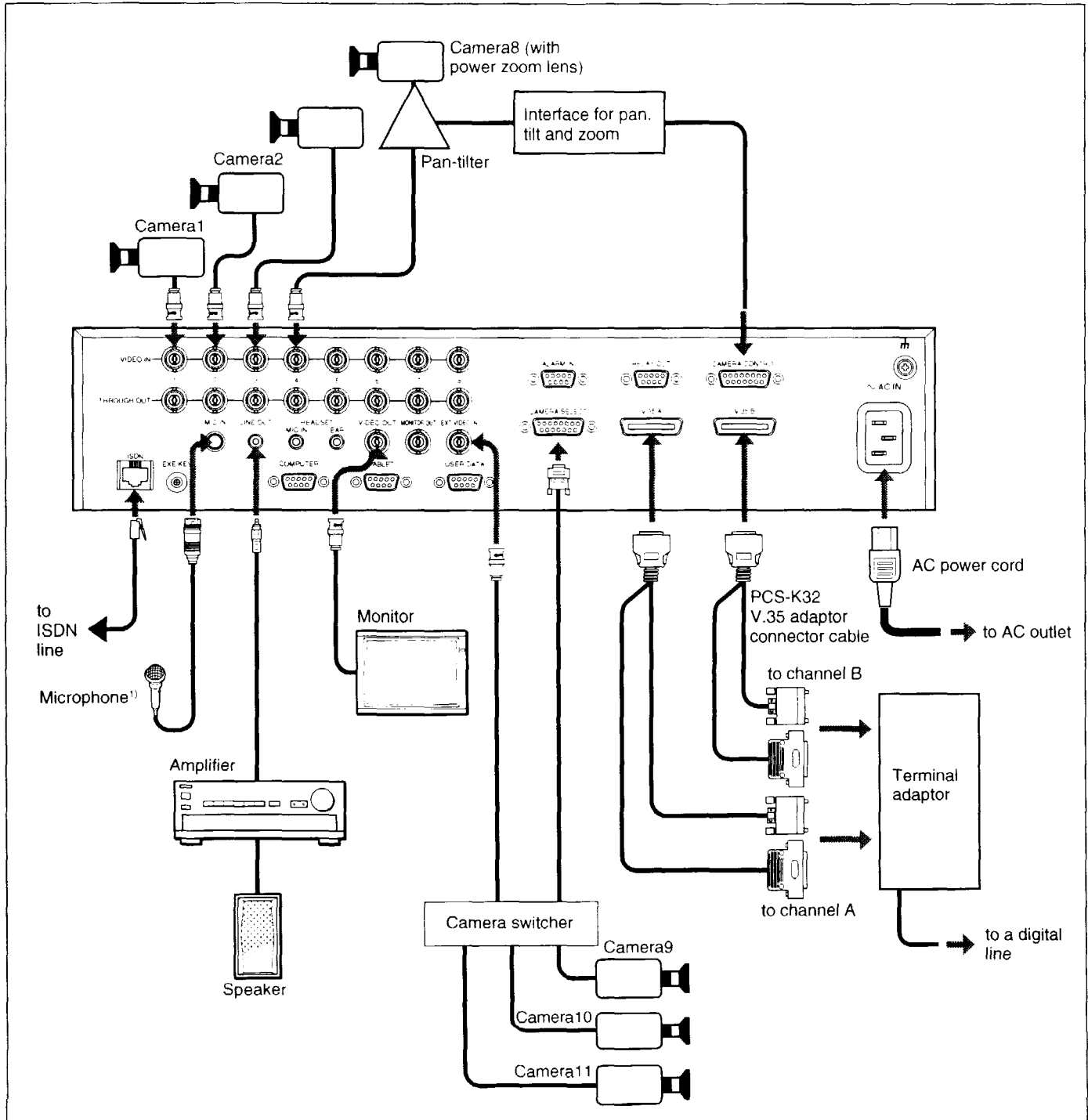

1) If you connect the microphone which has an XLR connector to the MIC IN jack, use the following audio conversion cable (not supplied).

- When the microphone has a female connector, use EC-0.4CM (17 3/4 inches (45 cm), 4-pin ↔ XLR (male)).
- When the microphone has a male connector, use EC-0.4CF (17 3/4 inches (45 cm), 4 pin ↔ XLR (female)).

Inserting the Batteries

- 1 Remove the battery cover.

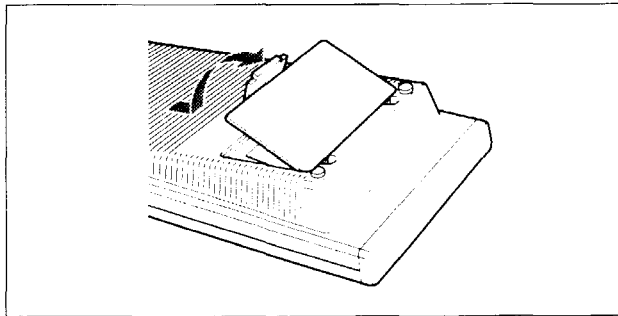

- 2 Insert two size AA (LR6) alkaline batteries with their polarities correctly aligned.

Caution

Be sure to install the negative \ominus end of the battery in first. If you place the positive \oplus end in first, there is a possibility of damaging the insulated film covering the battery and creating a short circuit.

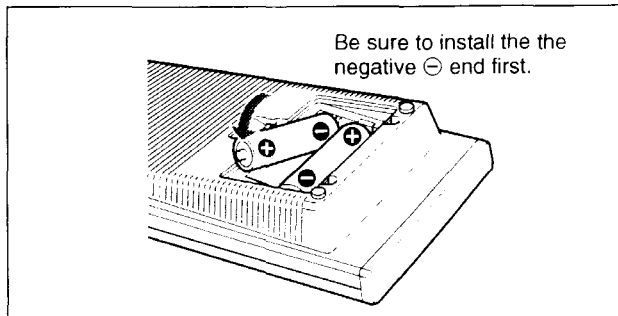

- 3 Replace the cover.

Battery life

When the batteries become weak or dead, the Remote Commander does not function.

Notes on batteries

To avoid possible damage from battery leakage or corrosion, observe the following.

- Be sure to insert the batteries in the correct direction.
- Do not mix old and new batteries or different types of batteries.
- Do not attempt to charge dry-cell batteries.
- If you do not intend to use the Remote Commander for a long time, remove the batteries.

If battery leakage occurs, clean the battery compartment and replace all the batteries.

Turning the Video Transmitter On

- 1 Turn on the devices connected to the Video Transmitter.
- 2 Press the POWER switch.
The Video Transmitter turns on and the POWER lamp (green) lights up.
After the initial screen is displayed, the DIAL LIST menu appears.
You can call the remote sites registered on this DIAL LIST menu.

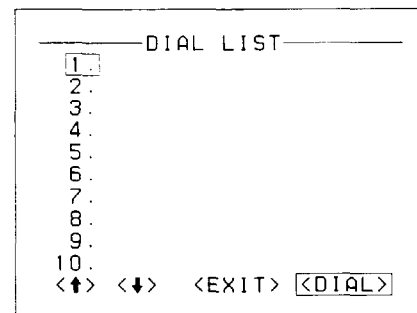

To go to the main menu

Move the cursor to <EXIT> using \leftarrow , \uparrow , \rightarrow or \downarrow , then press ENTER.

Note

If you are not going to use the unit for a long time, turn off the POWER switch.

Turning the Video Transmitter Off

Press the POWER switch.

The Video Transmitter is turned off and the POWER lamp goes off.

Cautions

- Do not turn off the power when you are setting an item in the SETTING menu. It may damage the registered data.
- The line may not be used temporarily if you turn off the power during communications.

When you operate the Video Transmitter, display the menu on the monitor.

Note

If an item in the menu is dimmed, that means the item cannot be selected.

To display the main menu

To display the main menu, press ENTER on the Video Transmitter or Remote Commander.

If you are using the tablet (WACOM ArtPad¹⁾ II for Windows²⁾, not supplied), select **ENTER** on the tablet.

Note

If you have set the main menu not to display, the menu is not displayed even if you press ENTER.

For details, see "Main menu display" on page 2-9 (EN).

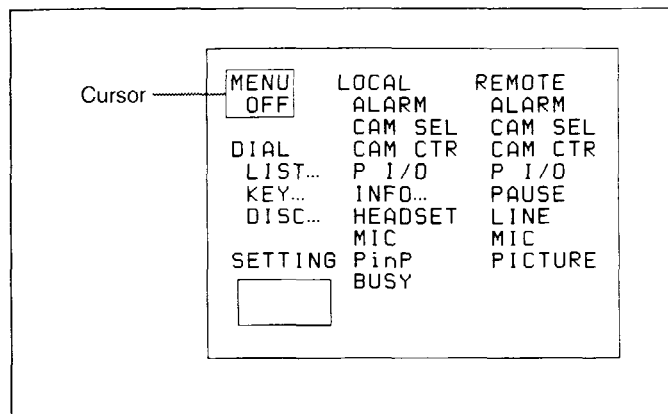

Main menu

LOCAL column: contains items which can be set for the local site.

REMOTE column: contains items which can be set for the remote site.

To clear the main menu

Select MENU OFF using ←, ↑, → or ↓, then press ENTER.

The main menu disappears from the monitor.

Operating the Menu

You can also operate the menu items directly from the Remote Commander or tablet (not supplied).

For details on Remote Commander operation, see pages A-4 (EN) and A-5 (EN), and on tablet operations, see Chapter 4.

Basic menu operations are described below.

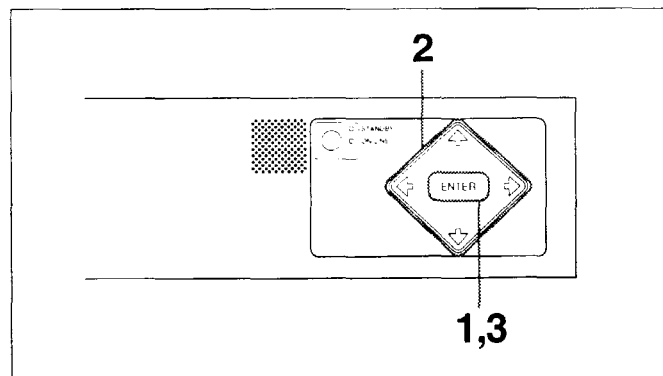

- 1** Press ENTER.
The main menu appears on the monitor.
- 2** Press ←, ↑, → or ↓ to move the cursor to the item you want to set.
The selected item becomes highlighted.
- 3** Press ENTER.
A menu for the selected item appears.
- 4** Make settings or adjustments on the item.

To cancel the operation

Move the cursor to <CANCEL> and press ENTER.
The operation is canceled.

To correct the characters

Move the cursor to BS (backspace) and press ENTER.
The last character is erased.

To return to the main menu

Move the cursor to <EXIT> and press ENTER.

Operating From a Computer

You can connect a computer to the Video Transmitter and control the Video Transmitter from the computer. For details on controlling the Video Transmitter from a computer, consult your nearest authorized dealer.

Menus

Items in the Main Menu

The main menu items are listed below.
When you turn off the Video Transmitter, all data are reset except for the items in the SETTING menu.

For details on items in the SETTING menu, see "Items in the SETTING Menu" on pages 2-1 (EN) and 2-2 (EN).

Item	Description	Page	
MENU OFF	Clears the main menu.	1-7 (EN)	
DIAL	LIST...	Connects to a registered remote site.	3-1 (EN)
	KEY...	Connects to an unregistered remote site.	3-2 (EN)
	DISC...	Disconnects the line.	3-3 (EN)
SETTING	Sets the preferences.	Chapter 2	
LOCAL	ALARM	Verifies alarm signals and log file input into the local ALARM IN port.	3-8 (EN)
	CAM SEL	Switches the picture of a camera connected to the local site.	3-5 (EN)
	CAM CTR	Controls the camera controller connected to the local site.	3-6 (EN)
	P I/O	Sets the bit value of the local RELAY OUT port.	3-9 (EN)
	INFO...	Selects the information to superimpose on the screen.	3-7 (EN)
	HEADSET	Selects headset volume.	3-4 (EN)
	MIC	Selects microphone input level.	3-4 (EN)
	PinP ^{a)}	Changes the position of the inset window.	3-7 (EN)
	BUSY ^{a)}	Makes the line busy temporarily.	3-3 (EN)
REMOTE	ALARM	Verifies alarm signals and log file input into the remote ALARM IN port.	3-8 (EN)
	CAM SEL ^{a)}	Switches the picture of a camera connected to the remote site.	3-5 (EN)
	CAM CTR ^{a)}	Controls the camera controller connected to the remote site.	3-6 (EN)
	P I/O	Sets the bit value of the remote RELAY OUT port.	3-9 (EN)
	PAUSE	Stops the camera auto scan temporarily.	3-5 (EN)
	LINE	Selects the line volume of the remote site.	3-4 (EN)
	MIC	Selects the microphone input level of the remote site.	3-4 (EN)
	PICTURE ^{a)}	Selects picture quality.	3-6 (EN)

a) Only for RSE-500

Setup Using the SETTING Menu

About the SETTING Menu

You can set the preferences for the Video Transmitter in the SETTING menu.

Items in the SETTING Menu

The SETTING menu list

Item	Description	Page
ID NAME	Registers the ID name.	2-3 (EN)
SITE NAME	Registers the site name.	2-3 (EN)
TELEPHONE#	Registers the telephone number of the local site.	2-3 (EN)
PASSWORD	Sets a password.	2-6 (EN)
LIST (NORMAL)	Registers remote sites. You can connect to a remote site from this menu.	2-15 (EN)
LIST (ALARM)	Registers remote sites to be connected when an alarm signal inputs.	2-16 (EN)
LIST (RECEIVE)	Registers remote sites which have gained access to the local site.	2-17 (EN)
CAMERA	Registers the total number of cameras.	2-13 (EN)
CAMERA AUTO SCAN	Sets the camera auto scan time.	2-14 (EN)
TIME OUT1	Sets the time-out period for the Video Transmitter to disconnect the line.	2-14 (EN)
TIME OUT2	Sets the time-out period for the Video Transmitter to be in the standby mode.	2-14 (EN)
AUDIO MIC LEVEL	Adjusts the line (headset) audio level and microphone input level.	2-7 (EN)
AUDIO-HEADSET	Selects the line (headset) volume. (HIGH/LOW/OFF)	2-8 (EN)
MIC	Selects the microphone input level. (HIGH/LOW/OFF)	2-8 (EN)
RINGER	Sets the ringer on or off.	2-9 (EN)
KEY SOUND	Sets sound on or off when you press the keys.	2-9 (EN)
PICTURE MODE ^{a)}	Selects the picture quality.	2-8 (EN)

(Continued)

About the SETTING Menu

Item	Description	Page
PinP ^{a)}	Selects the inset window to display or not and selects the position of the inset window.	2-10 (EN)
CALENDAR	Sets the date and time.	2-6 (EN)
MENU	Prevents the unit from displaying the main menu when using ENTER on the Video Transmitter or the enter key on the Remote Commander.	2-9 (EN)
ALARM IN	Writes the comment for the ALARM IN port.	2-10 (EN)
PARALLEL I/O	Writes the comment for the RELAY OUT port.	2-11 (EN)
CAMERA CONTROL	Sets input/output of the CAMERA CONTROL port.	2-11 (EN)
COMPUTER	Sets up the COMPUTER port.	2-11 (EN)
RS-232C 1	Sets up the TABLET port.	2-12 (EN)
RS-232C 2	Sets up the USER DATA port.	2-13 (EN)
VERSION	Displays the software version.	2-9 (EN)
MAINTENANCE	Diagnoses overall system functioning. Sets the second telephone number.	2-18 (EN)
RECEIVE CHECK	Checks whether the incoming call number and the remote site are the same.	2-18 (EN)
DIAG	Diagnoses particular system components.	2-19 (EN)
ANSWERING MODE	Sets the answering mode to auto or manual.	2-7 (EN)
COMMUNICATION MODE	Sets the line rate and the V.35 A/B ports.	2-5 (EN)
BRI MISC	Checks the ISDN interface.	2-21 (EN)

a) Only for RSE-500

Selecting an Item in the SETTING Menu

- 1 Select SETTING from the main menu.
The SETTING menu appears.

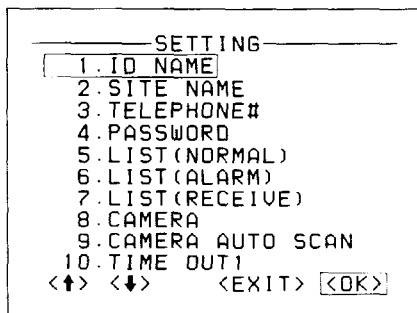

To move from page to page on the SETTING menu

Move the cursor to <↓> using ↓. Each time you press ENTER, the next SETTING menu is displayed.
Move the cursor to <↑> using ↑. Each time you press ENTER, the previous SETTING menu is displayed.

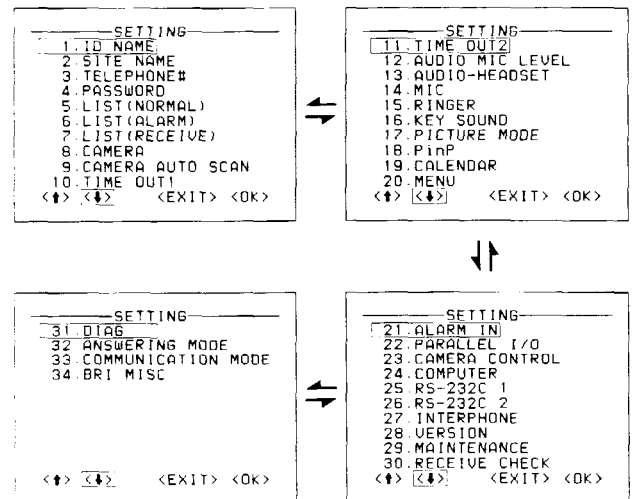

- 2 Select the item to be set using ↑ or ↓, then press ENTER.
The screen with available settings for each item appears.

To return to the main menu

Select <EXIT> using ← or →, then press ENTER.
The main menu appears.

Registering the Local Site Information

Before you use the Video Transmitter, register a site name and telephone number. You can also set a password to deny access to general calling parties other than specific calling parties.

Naming the Video Transmitter (ID Name)

An ID name is used only in system management for commenting purposes. It is not used for communication among Video Transmitter units.

- 1 Select 1. ID NAME from the SETTING menu. The following screen appears.

```
ID NAME : [*****]
@123456789
ABCDEFGHIJKLMNQP
RSTUVWXYZ
abcdefghijklmnop
qrstuvwxyz
!"#$%&'()*+,-.:;:
<=>?@[^_`{|}~+x/\^
SP BS

<CANCEL> <OK>
```

- 2 Select characters for the ID name using **←**, **↑**, **→** or **↓**, then press ENTER character by character. The selected characters are entered in the ID name box.
 - The ID name can be up to 10 characters long.
 - Select SP for a space.
 - An asterisk is displayed where nothing is entered.
- 3 After entering the ID name, move the cursor to **<OK>** using **↓**, then press ENTER. The ID name is registered and the SETTING menu appears.

Naming the Video Transmitter (Site Name)

The site name registered at your own site is displayed in the remote site monitor.

- 1 Select 2. SITE NAME from the SETTING menu. The following screen appears.

```
SITE NAME :
[*****]
@123456789
ABCDEFGHIJKLMNQP
RSTUVWXYZ
abcdefghijklmnop
qrstuvwxyz
!"#$%&'()*+,-.:;:
<=>?@[^_`{|}~+x/\^
SP BS

<CANCEL> <OK>
```

- 2 Press **↓** and select the characters for the site name using **←**, **↑**, **→** or **↓**, then press ENTER character by character. The selected characters are entered in the site name box.
 - The site name can be up to 20 characters long.
 - Select SP for a space.
 - An asterisk is displayed where nothing is entered.
- 3 After entering the site name, move the cursor to **<OK>** using **↓**, then press ENTER. The site name is registered and the SETTING menu appears.

Registering the Telephone Number and Subaddress

- 1 Select 3. TELEPHONE # from the SETTING menu. The following screen appears.

```
————— TELEPHONE# —————

COUNTRY CODE : [***]
@123456789 BS

<CANCEL> <OK>
```

Registering the Local Site Information

- 2** Select your country code using **←** or **→**, then press ENTER one by one.

The code is entered in the country code box.

- Enter the country code from the left row.
- Do not enter the first or second zero (e.g., enter "1" for the USA or Canada.)
- An asterisk is displayed where nothing is entered.

- 3** After entering the country code, move the cursor to <OK> using **↓**, then press ENTER.

The following screen appears.

```
-----TELEPHONE#-----
      SPID1:
[*****]
      0123456789 BS
      <CANCEL> <OK>
```

- 4** Select your SPID (service profile identifiers) for B1-channel using **←** or **→**, then press ENTER one by one.

The selected number is entered in the SPID1 box.

- SPID setting is only for users in the USA or Canada.
- An asterisk is displayed where nothing is entered.

- 5** After entering the SPID number, move the cursor to <OK> using **↓**, then press ENTER.

The following screen appears.

```
-----TELEPHONE#-----
      SPID1:
[0123456789 ]
      LDN1:
[*****]
      0123456789 BS
      <CANCEL> <OK>
```

- 6** Select your local directory number for B1-channel using **←** or **→**, then press ENTER one by one.

The selected number is entered in the LDN1 box.

- An asterisk is displayed where nothing is entered.
- Do not enter your area code.

- 7** After entering the local directory number, move the cursor to <OK> using **↓**, then press ENTER. The following screen appears.

```
-----TELEPHONE#-----
      SPID1:
[0123456789 ]
      LDN1:
[0123456789 ]
      SUB ADDRESS: [*****]
      0123456789 BS
      <CANCEL> <OK>
```

- 8** Enter a subaddress for B1-channel using **←** or **→**, then press ENTER one by one.

The selected number is entered in the subaddress box.

- A subaddress can be up to 10 digits.
- An asterisk is displayed where nothing is entered.

- 9** After entering the subaddress, move the cursor to <OK> using **↓**, then press ENTER.

The following screen appears.

```
-----TELEPHONE#-----
      SPID2:
[0123456789 ]
      LDN2:
[0123456789 ]
      SUB ADDRESS: [*****]
      0123456789 BS
      <CANCEL> <OK>
```

- 10** Repeat steps **4** to **9** to register SPID2, LDN2 and the subaddress for B2-channel.

The setting is registered and the SETTING menu appears.

What's a SPID?

SPIDs are Service Profile Identifiers. SPIDs are used to identify the ISDN device and allow a large uniformity for setting the ISDN device with a switcher.

When the system connects to the following types of network switcher, you can use ISDN lines and will have to register the SPID.

- AT&T 5ESS
 - Network switcher software: 5E8 or later (for National ISDN-1 and National ISDN-2)
- Northern Telecom (NT1) DMS-100
 - Network switcher software: BCS34 or later (for National ISDN-1 and National ISDN-2)

About custom ISDN

The Vidio Transmitter can communicate with custom ISDN. In such case, please use the following particular country codes.

- AT&T 5ESS Multipoint custom 110
- AT&T 5ESS Point to Point custom 112
- Northern Telecom DMS-100 custom 111

Setting the Communication Mode

When your country or region has a 56 Kbps line rate, set the ISDN line rate.

When you connect via the V.35 interface, set the number of channels and line rate.

- 1 Select 33. COMMUNICATION MODE from the SETTING menu.

The following screen appears.

```
— COMMUNICATION MODE —
  MODE: 64K 56K
V35 PORT: DUAL SINGLE
  RATE: 11281K
          123456
          <CANCEL> <OK>
```

- 2 When you connect the remote site via ISDN, select the line rate for sending and receiving using ◀ or ▶, then press ↓.

64K: via normal ISDN line.

56K: specific regions or countries with a 56 Kbps ISDN line rate.

- 3 When you connect the remote site via the V.35 interface, select the number of channels using ◀ or ▶, then press ↓.

DUAL: when you use both the CHANNEL A and B ports of the terminal adaptor.

SINGLE: when you use only the CHANNEL A port of the terminal adaptor.

- 4 Select the line rate of the V.35 interface for receiving using ◀ or ▶, then press ↓.
 - When you use both the CHANNEL A and B ports of the terminal adaptor, set the line rate to 128 K.
 - When you only use the CHANNEL A port of the terminal adaptor, set the line rate between 64 and 384 K.

- 5 After entering the line rate, move the cursor to <OK> using ↓, then press ENTER. The setting is registered and the SETTING menu appears.

Registering the Local Site Information

Notes

- When you connect via the V.35 interface, the terminal adaptor is required.
- When you connect via the V.35 interface, you need to set the line rates of the calling party and called party to the same rate.
- Turn on the terminal adaptor after turning on the Video Transmitter.

Setting the Password

You can set a password for security purposes. (If you do not set a password, you can connect to video-conference.)

When a remote party which does not know the password tries to connect to the local site, the line may be connected temporarily and the local picture and audio may be sent to the remote party. If you reject the communications other than specific parties, use the LIST (RECEIVE) menu and register the parties to permit the communications.

- 1 Select 4. PASSWORD from the SETTING menu. The following screen appears.

```
PASSWORD: ON OFF
[*****]

0123456789
ABCDEFGHIJKLMNP
QRSTUVWXYZ
abcdefghijklmno
pqrstuvwxyz
!"#$%&'()*+,-.:;
<=>?@[ \ ^ _ ] ( ) ~ x / \ ©
SP BS

<CANCEL> <OK>
```

- 2 Select ON or OFF using ◀ or ▶ to determine whether to set a password or not, then press ↓.
ON: Sets the password.
OFF: Does not set the password, but you can still register a password.
- 3 Select characters for the password using ◀, ↑, ▶ or ↓, then press ENTER character by character. The selected characters are entered in the password box.
 - The password can be up to 15 characters long.
 - Select SP for a space.
 - An asterisk is displayed where nothing is entered.

- 4 After entering the password, move the cursor to <OK> using ↓, then press ENTER. The password is registered and the SETTING menu appears.

Setting the Date and Time

- 1 Select 19. CALENDAR from the SETTING menu. The following screen appears.

```
----- CALENDAR -----
YY.MM.DD HH:MM:SS
[98.07.04 01:50:57]

[0]123456789 ← →

<CANCEL> <OK>
```

- 2 If you set all the date and time, go to Step 3. To select the item of date or time you want to set, select ◀ or ▶ using the ◀ or ▶ key and press ENTER repeatedly to move the cursor. The cursor moves among the date (YY.MM.DD) and time (HH:MM:SS) cyclically.

YY	MM	DD	HH	MM	SS
Year	Month	Date	Hour	Minute	Second

- 3 Select a number using ◀ or ▶, then press ENTER. The selected number is entered in the box and the cursor moves to the right.
- 4 Repeat Steps 2 and 3 to enter the date and time.
- 5 After entering the date and time, move the cursor to <OK> using ↓, then press ENTER. The date and time are set and the SETTING menu appears.

Mode

You can set the answering mode to receive an incoming call automatically or manually.

- 1 Select 32. ANSWERING MODE from the SETTING menu.
The following screen appears.

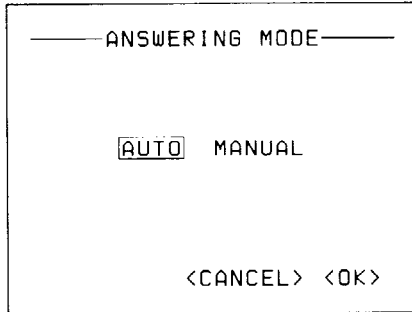

- 2 Select AUTO or MANUAL using \leftarrow or \rightarrow .
The selected setting becomes highlighted.
AUTO: Receives an incoming call automatically.
MANUAL: Before receiving an incoming call, the message “There is an incoming video call...” appears on the monitor. If you want to receive that call, press ENTER.
- 3 Move the cursor to <OK> using \downarrow , then press ENTER.
The setting is registered and the SETTING menu appears.

Basic Setting

This section describes the basic settings of the Video Transmitter.

Adjusting the Line (Headset) Audio Level and the Microphone Input Level

You can register the line (headset) audio level and microphone input level in the HIGH and the LOW positions.
If you set AUDIO to OFF, the capacity allocated to the audio signal is allocated to the video signal. In this case, the picture quality improves.

- 1 Select 12. AUDIO MIC LEVEL from the SETTING menu.
The following screen appears.

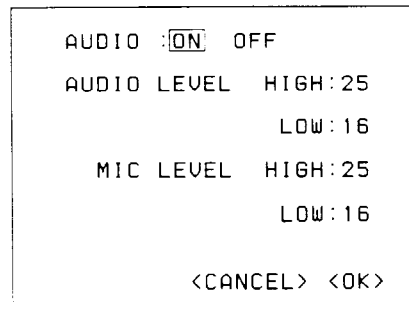

- 2 Select ON or OFF using \leftarrow or \rightarrow , then press \downarrow .
- 3 Adjust the audio level in the HIGH position using \leftarrow or \rightarrow .
You can adjust the audio level between 01 and 32.
- 4 Move the cursor to AUDIO LEVEL LOW using \downarrow , then adjust the audio level in the LOW position using \leftarrow or \rightarrow .
You can adjust the audio level between 01 and 32.
- 5 Move the cursor to MIC LEVEL HIGH using \downarrow , then adjust the microphone input level in the HIGH position using \leftarrow or \rightarrow .
You can adjust the microphone input level between 01 and 32.
- 6 Move the cursor to MIC LEVEL LOW using \downarrow , then adjust the microphone input level in the LOW position using \leftarrow or \rightarrow .
You can adjust the microphone input level between 01 and 32.



Basic Setting

- 7 Move the cursor to <OK> using \downarrow , then press ENTER.
The audio level and microphone input level are set and the SETTING menu appears.

Note

If you set a low level in the HIGH position and a high level in the LOW position, low level is output (or input) regardless of selecting HIGH and high level is output (or input) regardless of selecting LOW.

Selecting the Line (Headset) Volume

- 1 Select 13. AUDIO-HEADSET from the SETTING menu.
The following screen appears.

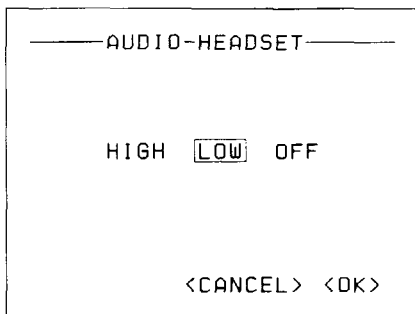

- 2 Select HIGH, LOW or OFF using \leftarrow or \rightarrow .
The selected setting becomes highlighted.
HIGH: The volume is set to the HIGH position level set in 12. AUDIO MIC LEVEL.
LOW: The volume is set to the LOW position level set in 12. AUDIO MIC LEVEL.
OFF: Sound is muted.
- 3 Move the cursor to <OK> using \downarrow , then press ENTER.
The setting is registered and the SETTING menu appears.

Selecting the Microphone Input Level

- 1 Select 14. MIC from the SETTING menu.
The following screen appears.

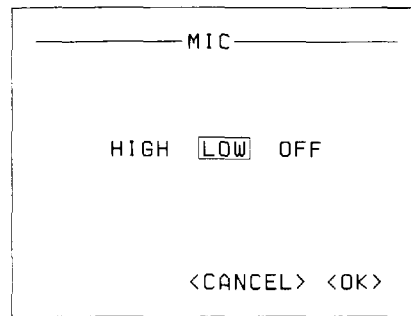

- 2 Select HIGH, LOW or OFF using \leftarrow or \rightarrow .
The selected setting becomes highlighted.
HIGH: The input level is set to the HIGH position level set in 12. AUDIO MIC LEVEL.
LOW: The input level is set to the LOW position level set in 12. AUDIO MIC LEVEL.
OFF: No sound is input.
- 3 Move the cursor to <OK> using \downarrow , then press ENTER.
The setting is registered and the SETTING menu appears.

Selecting the Picture Quality

- 1 Select 17. PICTURE MODE from the SETTING menu.
The following screen appears.

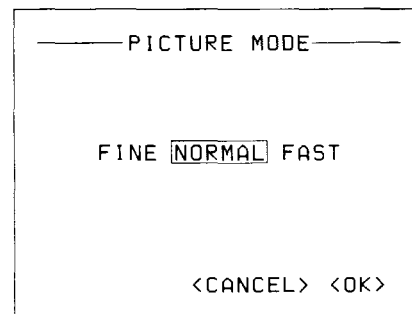

- 2 Select the picture quality using \leftarrow or \rightarrow .
The selected setting becomes highlighted.
FINE: Gives picture quality preference than picture motion.
NORMAL: Middle setting between FINE and FAST.
FAST: Gives picture motion preference than picture quality.
- 3 Move the cursor to <OK> using \downarrow , then press ENTER.
The picture quality is set and the SETTING menu appears.

Other Settings

Ringer

You can set the ringer sound on or off.
Select 15. RINGER from the SETTING menu and select ON or OFF using ◀ or ▶.

ON: Ringer is turned on.

OFF: Ringer is turned off.

Move the cursor to <OK> using ▼ and press ENTER.
The setting is registered and the SETTING menu appears.

Key sound

You can make a sound when you press a key.
Select 16. KEY SOUND from the SETTING menu and select ON or OFF using ◀ or ▶.

ON: Key sound is turned on.

OFF: Key sound is turned off.

Move the cursor to <OK> using ▼ and press ENTER.
The setting is registered and the SETTING menu appears.

Main menu display

You can set the unit to prevent it from displaying the main menu when ENTER on the Video Transmitter or the enter key on the Remote Commander is pressed.
Select 20. MENU from the SETTING menu and select ON or OFF using ◀ or ▶.

ON: Main menu is displayed.

OFF: Main menu is not displayed.

Move the cursor to <OK> using ▼ and press ENTER.
The setting is registered and the SETTING menu appears.

To display the software version

You can check the software version.

- 1 Select 28. VERSION from the SETTING menu.
The following screen appears.

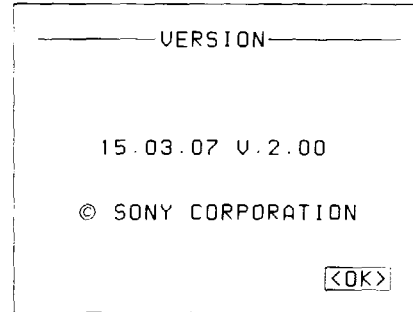

- 2 After checking the software version, press ENTER.
The SETTING menu appears.

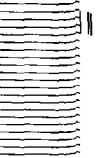

Inset Window Setting

You can set the unit to display the inset window and select the corner in which the inset window appears on.

Selecting the Position of the Inset Window

- 1 Select 18. PinP from the SETTING menu. The following screen appears.

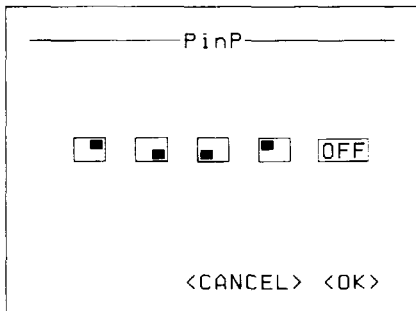

- 2 Select the position of the inset window using \leftarrow or \rightarrow .

The selected setting becomes highlighted.

- : The inset window is displayed in the upper-right corner.
- : The inset window is displayed in the lower-right corner.
- : The inset window is displayed in the lower-left corner.
- : The inset window is displayed in the upper-left corner.

OFF: The inset window is not displayed.

- 3 Move the cursor to \leftarrow using \downarrow , then press ENTER. The inset window position is set and the SETTING menu appears.

Port Setting

This section describes how to set the ALARM IN, RELAY OUT, CAMERA CONTROL, COMPUTER, TABLET, USER DATA ports.

Setting Up the ALARM IN Port

You can write comments for the ALARM IN port to identify what is connected to each port.

- 1 Select 21. ALARM IN from the SETTING menu. The following screen appears.

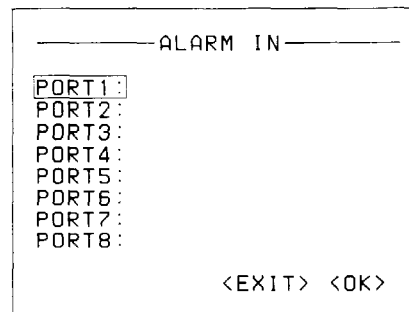

- 2 Select the port number (PORT1 – 8) using \uparrow or \downarrow , then press ENTER.

The following screen appears.

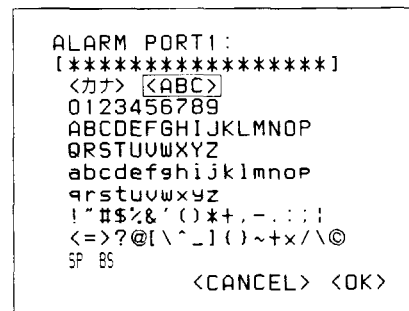

- 3 Press \downarrow and select characters using \leftarrow , \uparrow , \rightarrow or \downarrow , then press ENTER character by character. Selected characters are entered in the box.
 - A comment can be up to 17 characters long.
 - Select SP for spaces.
 - An asterisk is displayed where nothing is entered.

- 4 After writing a comment, move the cursor to \leftarrow using \downarrow , then press ENTER. The comment is registered and the SETTING menu appears.

Setting Up the RELAY OUT Port

You can select input or output for the RELAY OUT port and write comments for the port to identify what is connected to each port.

- 1 Select 22. PARALLEL I/O from the SETTING menu.
The following screen appears.

```
----- PARALLEL I/O -----
PORT1: IN
PORT2: IN
PORT3: IN
PORT4: IN
PORT5: IN
PORT6: IN
PORT7: IN
PORT8: IN

<EXIT> <OK>
```

- 2 Select the port number (PORT1 – 8) using \uparrow or \downarrow , then press ENTER.
The following screen appears.

```
P I/O      PORT1: IN OUT
[*****]
<カナ> <ABC>
0123456789
ABCDEFGHIJKLMN OP
QRSTUVWXYZ
abcdefghijklmnop
qrstuvwxyz
! " # $ % & ' ( ) * + , - . : ;
<=> ? @ [ \ ^ _ ] ( ) ~ + x \ \
SP BS
<CANCEL> <OK>
```

- 3 Select IN or OUT using \leftarrow or \rightarrow , then press \downarrow .
The cursor moves to <ABC>.
- 4 Press \downarrow and select characters using \leftarrow , \uparrow , \rightarrow or \downarrow , then press ENTER character by character.
Selected characters are entered in the box.
 - A comment can be up to 17 characters long.
 - Select SP for a space.
 - An asterisk is displayed where nothing is entered.
- 5 After writing a comment, move the cursor to <OK> using \downarrow , then press ENTER.
The setting is registered and the SETTING menu appears.

Setting Up the CAMERA CONTROL Port

You can select input or output of the CAMERA CONTROL port.

- 1 Select 23. CAMERA CONTROL from the SETTING menu.
The following screen appears.

```
----- CAMERA CONTROL -----

INPUT  OUTPUT

<CANCEL> <OK>
```

- 2 Select INPUT or OUTPUT using \leftarrow or \rightarrow .
- 3 Move the cursor to <OK> using \downarrow , then press ENTER.
The setting is registered and the SETTING menu appears.

Setting Up the COMPUTER Port

- 1 Select 24. COMPUTER from the SETTING menu.
The following screen appears.

```
INTERFACE: RS-232C
BAUD RATE: 1200
           2400
           4800
           9600
           19200
           38400

<CANCEL> <OK>
```

Port Setting

- 2 Select the baud rate using \uparrow or \downarrow , then press ENTER.

The following screen appears.

```
INTERFACE:RS-232C
BAUD RATE:9600
CHARACTER BIT:7 8
<CANCEL> <OK>
```

- 3 Select the character bit using \leftarrow or \rightarrow , then press ENTER.

The following screen appears.

```
INTERFACE:RS-232C
BAUD RATE:9600
CHARACTER BIT:8
PARITY BIT:NONE
          ODD
          EVEN
<CANCEL> <OK>
```

- 4 Select the parity bit using \uparrow or \downarrow , then press ENTER.

The following screen appears.

```
INTERFACE:RS-232C
BAUD RATE:9600
CHARACTER BIT:8
PARITY BIT:NONE
STOP BIT:1 1.5 2
<CANCEL> <OK>
```

- 5 Select the stop bit using \leftarrow or \rightarrow , then press ENTER.

The setting is registered and the SETTING menu appears.

Setting Up the TABLET Port

- 1 Select 25. RS-232C 1 from the SETTING menu. The following screen appears.

```
INTERFACE:TABLET
          RS-232C
          RS-422A
<CANCEL> <OK>
```

- 2 Select the interface using \uparrow or \downarrow , then press ENTER.

If you are using the tablet (WACOM ArtPad II for Windows, not supplied), select TABLET.

The following screen appears.

```
INTERFACE:TABLET
BAUD RATE:1200
          2400
          4800
          9600
          19200
          38400
<CANCEL> <OK>
```

- 3 Select the baud rate using \uparrow or \downarrow , then press ENTER.

- 4 Select the character bit using \leftarrow or \rightarrow , then press ENTER.

- 5 Select the parity bit using \uparrow or \downarrow , then press ENTER.

- 6 Select the stop bit using \leftarrow or \rightarrow , then press ENTER.

The setting is registered and the SETTING menu appears.

Number of Cameras

Setting Up the USER DATA Port

- 1 Select 26. RS-232C 2 from the SETTING menu.
The following screen appears.

```
INTERFACE: RS-232C
           YS-S100
           MASTER

<CANCEL> <OK>
```

- 2 Select the interface using \uparrow or \downarrow , then press ENTER.
If you are using the YS-S100 Camera Switcher (not supplied), select YS-S100 MASTER.
The following screen appears.

```
INTERFACE: YS-S100
           MASTER
BAUD RATE: 1200
           2400
           4800
           9600
           19200
           38400

<CANCEL> <OK>
```

- 3 Select the baud rate using \uparrow or \downarrow , then press ENTER.
- 4 Select the character bit using \leftarrow or \rightarrow , then press ENTER.
- 5 Select the parity bit using \uparrow or \downarrow , then press ENTER.
- 6 Select the stop bit using \leftarrow or \rightarrow , then press ENTER.
The setting is registered and the SETTING menu appears.

You need to register the number of cameras (up to 256) connected to the Video Transmitter to monitor all of the camera pictures. You cannot switch to all of the pictures if you don't register the number of cameras.

Registering the Number of Cameras Connected to the Video Transmitter

- 1 Select 8. CAMERA from the SETTING menu.
The following screen appears.

```
————— CAMERA —————
NO: [ ]**]
    [ ]123456789 BS

<CANCEL> <OK>
```

- 2 Select the number of cameras connected to the Video Transmitter using \leftarrow or \rightarrow , then press ENTER.
The selected number is entered in the box.
 - An asterisk is displayed where nothing is entered.
- 3 Move the cursor to <OK> using \downarrow , then press ENTER.
The setting is registered and the SETTING menu appears.



Automatically

You can automatically switch among the pictures (up to 256 cameras) at regular intervals.

Setting the Time When the Pictures are Switched

- 1 Select 9. CAMERA AUTO SCAN from the SETTING menu.

The following screen appears.

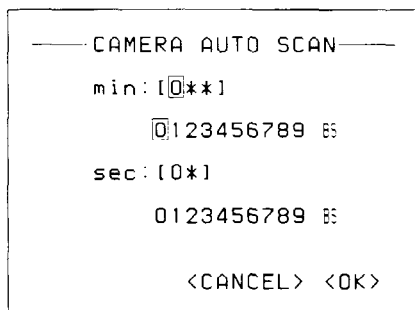

- 2 Select the minutes using ◀ or ▶, then press ENTER one by one.
The selected number is entered in the minutes box.
Press ▼ and select the seconds using ◀ or ▶, then press ENTER one by one.
The selected number is entered in the seconds box.
 - An asterisk is displayed where nothing is entered.
 - If you select 0 for minutes and seconds, the pictures are not switched automatically.

- 3 Move the cursor to <OK> using ▼, then press ENTER.
The setting is registered and the SETTING menu appears.

Automatically/Turning to the Standby Mode Automatically

You can set the system to disconnect the line automatically or turn to standby mode automatically to save power.

Setting the Time When the Unit Disconnects From the Line or Turning to the Standby Mode

- 1 To set the time when the unit disconnects from the line, select 10. TIME OUT 1 from the SETTING menu.

To set the time when the unit turns to the standby mode, select 11. TIME OUT 2 from the SETTING menu.

The following screen appears. (The illustration below is for selecting 10. TIME OUT 1.)

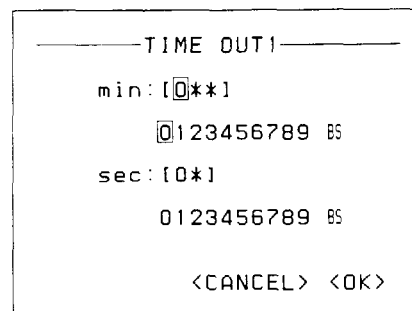

- 2 Select the minutes using ◀ or ▶, then press ENTER one by one.
The selected number is entered in the minutes box.
Press ▼ and select the seconds using ◀ or ▶, then press ENTER one by one.
The selected number is entered in the seconds box.
 - An asterisks is displayed where nothing is entered.
 - If you select 0 for minutes and seconds, the unit does not automatically disconnect from the line or turn to the standby mode.

- 3 Move the cursor to <OK> using ▼, then press ENTER.
The setting is registered and the SETTING menu appears.

To turn on the power from the standby mode

- Press any key on the Video Transmitter or Remote Commander.
- Select any location on the tablet (not supplied).

Is Input

You can register up to 10 called parties for one port number of the ALARM IN port when an alarm signal is input. If an alarm signal is input, the unit calls these parties automatically.

Registering Your Called Party Information

- 1 Select 6. LIST (ALARM) from the SETTING menu.
The LIST (ALARM) menu appears.

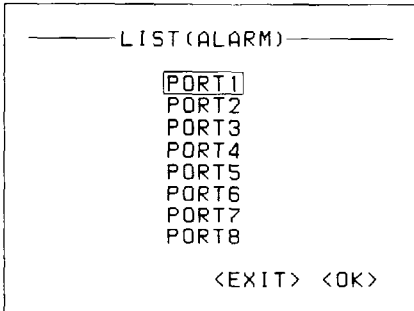

- 2 Select the port number (PORT 1 – 8) using \uparrow or \downarrow , then press ENTER.
The following screen appears.

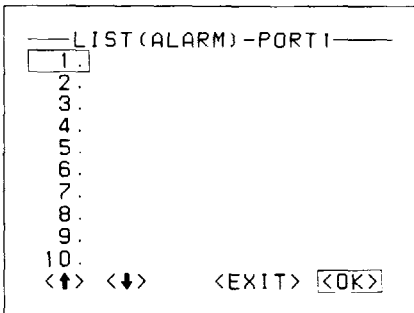

- 3 Select the list number (1 – 10) to register the called party using \uparrow or \downarrow , then press ENTER.
The following screen appears.

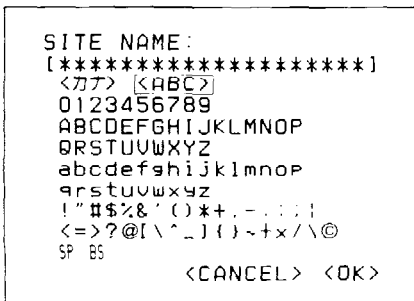

- 4 Press \downarrow and select the site name using \leftarrow or \rightarrow , then press ENTER character by character.
The selected characters are entered in the site name box.
 - A site name can be up to 20 characters long.
 - Select SP for a space.
 - An asterisk is displayed where nothing is entered.

- 5 Move the cursor to <OK> using \downarrow , then press ENTER.
The following screen appears.

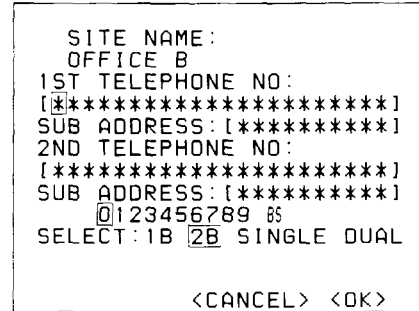

- 6 Enter the telephone number for B1-channel using \leftarrow or \rightarrow , then press ENTER one by one.
The selected numbers are entered in the first telephone number box.
 - A telephone number can be up to 22 digits.
 - An asterisk is displayed where nothing is entered.
- 7 Press \downarrow and enter the subaddress for B1-channel using \leftarrow or \rightarrow , then press ENTER.
The selected numbers are entered in the subaddress box.
 - A telephone number can be up to 10 digits.
 - An asterisk is displayed where nothing is entered.

- 8 Press \downarrow and repeat steps 6 and 7 to register the telephone number and subaddress for B2-channel.

- 9 Press \downarrow and select the transmission rate (via an ISDN line from 1B or 2B, via the V.35 interface from SINGLE or DUAL) using \leftarrow or \rightarrow , then press ENTER.

The setting is registered and the LIST (ALARM) menu appears.

Note

The subaddress function may not be worked properly depending on types of switchboards.

You can register up to 128 calling parties with permission to be connected.

Note

This function may not be worked properly depending on types of switchboards.

Registering Your Calling Party Information

- 1 Select 7. LIST (RECEIVE) from the SETTING menu.

The LIST (RECEIVE) menu appears.

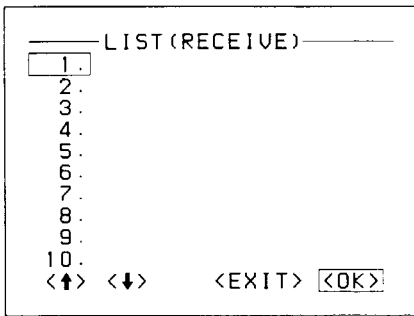

To move from page to page on the LIST (RECEIVE) menu

Move the cursor to <↓> using <↓>. Each time you press ENTER, the next LIST (RECEIVE) menu is displayed.

Move the cursor to <↑> using <↑>. Each time you press ENTER, the previous LIST (RECEIVE) menu is displayed.

- 2 Select the list number to register the calling party using <↑> or <↓>, then press ENTER.

The following screen appears.

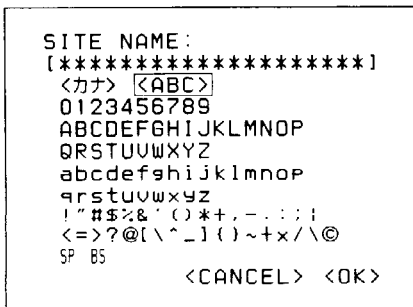

- 3 Press <↓> and select the site name using <←> or <→>, then press ENTER character by character.

The selected characters are entered in the site name box.

- The site name can be up to 20 characters long.
- Select SP for spaces.
- An asterisk is displayed where nothing is entered.

- 4 Move the cursor to <OK> using <↓>, then press ENTER.

The following screen appears.

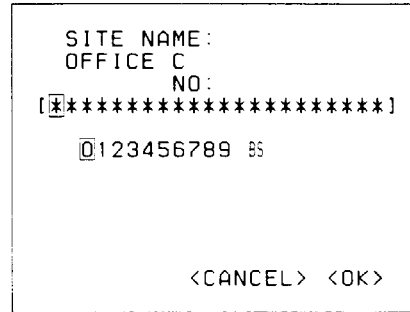

- 5 Enter the telephone number using <←> or <→>, then press ENTER one by one.

The selected numbers are entered in the telephone number box.

- A telephone number can be up to 22 digits.
- An asterisk is displayed where nothing is entered.
- When you connect at 2B transmission rate, enter the telephone number for B1-channel.

- 6 Move the cursor to <OK> using <↓>, then press ENTER.

The setting is registered and the LIST (RECEIVE) menu appears.

Checking the Calling Party or Called Party Number

You can check a call against the numbers registered on the LIST (RECEIVE) menu. If you set RECEIVE CHECK to ON, the unit cannot receive any calls other than from the registered numbers.

If you set LDN CHECK to ON, the unit checks a called party number against your local directory number.

- 1 Select 30. RECEIVE CHECK from the SETTING menu.

The following menu appears.

```
-----RECEIVE CHECK-----  
  
RECEIVE CHECK  ON  OFF  
LDN CHECK      ON  OFF  
  
<CANCEL> <OK>
```

- 2 Select receive check ON or OFF using \leftarrow or \rightarrow , then press \downarrow .
- 3 Select LDN check ON or OFF using \leftarrow or \rightarrow , then press \downarrow .
- 4 Press ENTER.
The setting is registered and the main menu appears.

Note

If you cannot receive a call, set LDN CHECK to OFF.

You can diagnose the Video Transmitter system. The diagnostics are executed by looping back the audio/video signals and serial data.

Setting the Loop Back and Debugging

- 1 Select 29. MAINTENANCE from the SETTING menu.

The following screen appears.

```
MAINTENANCE  
-----  
OFF LOOP BACK  
OFF DEBUG  
OFF HEALTH CHECK  
OFF 2ND TELEPHONE#  
2ND TELEPHONE# :  
[*****]  
SUB ADDRESS : [*****]  
  
0123456789 B5  
<CANCEL> <OK>
```

- 2 Select loop back ON or OFF using \leftarrow or \rightarrow , then press \downarrow .
- 3 Select debugging ON or OFF using \leftarrow or \rightarrow , then press \downarrow three times.
- 4 Press ENTER.
The setting is registered.

When LOOP BACK is set to ON

The analog video input signal from the camera is digitized and encoded when you call through the DIAL LIST menu. This signal is looped back and decoded before sending it via ISDN. This decoded signal is displayed on the monitor after converting to an analog signal.

When DEBUG is set to ON

The ISDN line connection status is output to the USER DATA port.

When HEALTH CHECK is set to ON

When the devices at remote site do not shut down properly, such as disconnect the line before turning off the devices, or error occurred in ISDN lines, disconnect the line properly.

Note

The health check does not function when the local Video Transmitter turns off the power before disconnecting the line.



To cancel diagnostics

Set LOOP BACK and DEBUG to OFF. Move the cursor to <EXIT> and press ENTER. Diagnostics are canceled and the main menu appears.

Setting a Different Telephone Number for B2-channel for Maintenance

- 1 Select 29. MAINTENANCE from the SETTING menu.
- 2 Press ↓ three times.
- 3 Set 2ND TELEPHONE# to ON using ← or →, then press ENTER.
- 4 Select the second telephone number of the remote site using ← or →, then press ENTER one by one. The second telephone number is entered in the second telephone number box.
 - An asterisk is displayed where nothing is entered.
- 5 After entering the second telephone number, move the cursor to <OK> using ↓, then press ENTER.
- 6 Select the second subaddress of the remote site using ← or →, then press ENTER one by one. The second subaddress is entered in the second subaddress box.
 - An asterisk is displayed where nothing is entered.
- 7 After entering the subaddress, move the cursor to <OK> using ↓, then press ENTER. The setting is registered and the SETTING menu appears.

Diagnosing the Hardware

Note

After executing diagnostics, all settings are reset to the same state as when the power is turned on except for the items in the SETTING menu.

Audio and video signals diagnostics

Notes

- For a video signal loop back, you need a camera and a monitor.
- For an audio signal loop back, you need a headset.

- 1 Select 31. DIAG from the SETTING menu. The following screen appears.

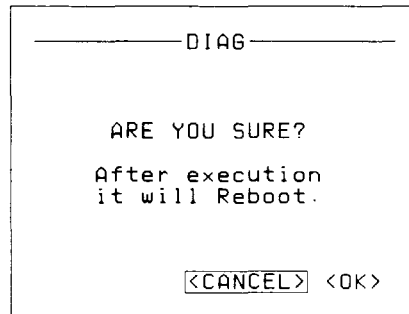

- 2 Select <OK> using →, then press ENTER. The following screen appears.

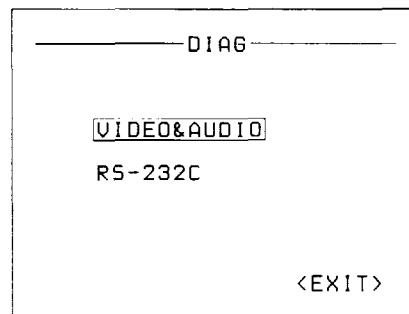

- 3 Select VIDEO & AUDIO, then press ENTER. The following screen appears.

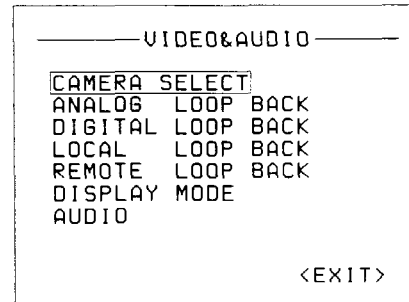

- 4 Select an item to diagnose using ↑ or ↓, then press ENTER. The hardware self-diagnostic starts.

Note

After executing the LOCAL LOOP BACK diagnostic, the DIGITAL LOOP BACK diagnostic cannot be executed.

Diagnosing the System

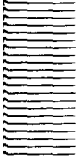

Items checked when the Video Transmitter is off-line

Item	Normal result
CAMERA SELECT	Changes the input signal and displays it on the monitor to diagnose the video signal I/O and the video switch. You can connect the monitor to either the VIDEO OUT connector or MONITOR OUT connector. Selected camera picture is displayed. If you select a port into which no video signal is input, there is no synchronization and nothing is displayed on the monitor.
ANALOG LOOP BACK	Displays the analog video signals on the monitor.
DIGITAL LOOP BACK	Displays the video signals which are converted to digital and then converted to analog again (compared to the analog signals, they are rough.)
LOCAL LOOP BACK	Displays the video signals which are encoded and decoded (compared to the digital signals, they appear frame by frame.)
DISPLAY MODE	Displays only character information or only input video signals. Each time you press ENTER, the screen changes between character information without picture and superimposed picture.
AUDIO	Outputs the audio signals input from the microphone to the headset or the line output.

Item checked when the Video Transmitter is on-line

Item	Normal result
REMOTE LOOP BACK	Displays the same status as LOCAL LOOP BACK above. REMOTE LOOP BACK is executed when it is on-line. After executing REMOTE LOOP BACK, the line is disconnected automatically and the unit returns to the same state as when the power is turned on.

To cancel the diagnostics

Move the cursor to <EXIT> and press ENTER. The data except for the SETTING menu are reset to the same state as when the power is turned on.

Serial data diagnostics

To check serial data, connect the loop back connector to the COMPUTER port, TABLET port and USER DATA port and diagnose by looping back the data sent from the Video Transmitter.

If you connect a loop back connector to a remote site when it is on-line, you can check the remote site during data transmission. If you connect a loop back connector to the local site when it is off-line, you can check the local site.

Notes

- To loop back serial data, you need a shorted loop back connector for pins 2 and 3, pins 4 and 6, and pins 7 and 8.
- A serial data loop back is done in RS-232C mode. For details on pin assignment, see "Pin Assignment" on pages A-9 (EN) to A-11 (EN).

- 1 Select 31. DIAG from the SETTING menu. The following screen appears.
- 2 Select <OK> using \blacktriangleright , then press ENTER. The following screen appears.
- 3 Select RS-232C using \blacktriangledown , then press ENTER. The following screen appears.

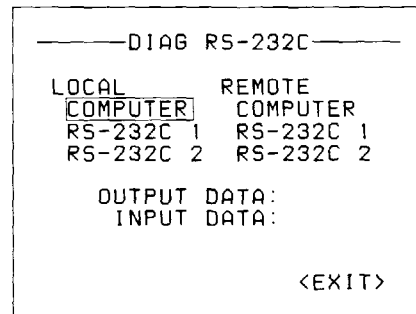

- 4 Select an item to check using \blacktriangleleft , \blacktriangleup , \blacktriangleright or \blacktriangledown then press ENTER. The system starts diagnostics. When the hardware is functioning correctly, the system displays OK.

To cancel the diagnostics

Move the cursor to <EXIT> and press ENTER. The data except for the SETTING menu are reset to the same state as when the power is turned on.

Checking the ISDN Interface

You can check the BRI interface software version, the Layer 1 status, or execute the loop back through the ISDN connection.

Checking the BRI interface

You can check the BRI interface software version. This item is only for checking.

- 1 Select 34. BRI MISC from the SETTING menu. The following screen appears.

```
-----BRI MISC-----
DIAG REQUEST[****]
INFO1 SIGNALS
LOOP BACK [OFF ]
LOCAL REQUEST
REMOTE REQUEST
OFF REQUEST
<EXIT>
```

- 2 Select DIAG REQUEST using \uparrow or \downarrow , then press ENTER. The BRI software version number displays in the DIAG REQUEST box.
- 3 After checking the version, move the cursor to <EXIT> using \downarrow , then press ENTER. The DIAL LIST menu appears.

Generating the INFO 1 Signal for Testing Layer 1

- 1 Select 34. BRI MISC from the SETTING menu.
- 2 Press \downarrow to select INFO1 SIGNALS.
- 3 Press ENTER. The INFO 1 signal generates and Layer 1 test starts.
- 4 After testing Layer 1, move the cursor to <EXIT> using \downarrow , then press ENTER. The DIAL LIST menu appears.

Note

This function is not available for normal communication.

Looping Back the Primitive

You can loop back the primitive of the request between the local and remote sites for another testing purpose.

- 1 Select 34. BRI MISC from the SETTING menu.
- 2 Press \downarrow twice.
- 3 Select loopback ON or OFF using \leftarrow or \rightarrow .
- 4 select LOCAL REQUEST, REMOTE REQUEST or OFF REQUEST using \uparrow or \downarrow .
- 5 Press ENTER. Loop back starts.
- 6 After finishing the loopback, move the cursor to <EXIT> using \downarrow , then press ENTER. The DIAL LIST menu appears.

Notes

- This function is not available for normal communication.
- You have to turn the Video Transmitters off and on at both sites after executing REMOTE REQUEST for next communication.



Operation

Starting Communication

To connect to a remote site, dial the telephone number as you would call a normal telephone. The Video Transmitter can send and receive voice, pictures and control data via one ISDN (BRI) line.

Connecting to a Remote Site

You can connect to a remote site in the following two ways. The connection method is different depending on whether a remote site has been registered or not.

To connect to a registered remote site

You have to register a called party in the SETTING menu before the communication.

For details, see "Registering Called Parties" on page 2-15 (EN).

* If the DIAL LIST menu is displayed, start from Step 2.

- 1 Select the DIAL LIST from the main menu. The DIAL LIST menu appears.

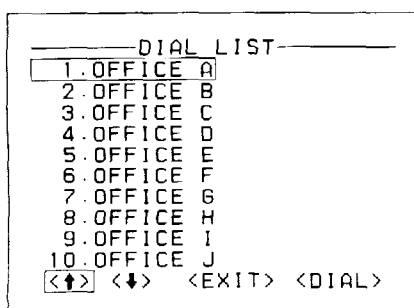

- 2 Select the remote site to connect using **↑** or **↓**, then press ENTER. The following screen appears and the system starts the connection process.

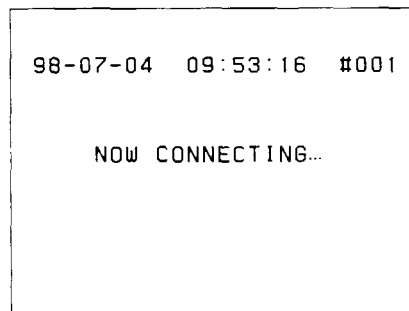

When the remote site is connected, the picture from the remote site is displayed.

To cancel the connection before connecting to a remote site

Press **←**.

If you are using the tablet (WACOM ArtPad II for Windows, not supplied), select **CANCEL** on the tablet.

To move from page to page on the DIAL LIST menu

Move the cursor to **<↓>** using **←** or **→**, then press ENTER. Each time you press ENTER, the next DIAL LIST menu is displayed.

Move the cursor to **<↑>** using **←** or **→**, then press ENTER. Each time you press ENTER, the previous DIAL LIST menu is displayed.

Starting Communication

If the connection failed

If the system cannot make a connection with the remote site, the following message and the ISDN cause code appear for five seconds and the DIAL LIST menu appears again.

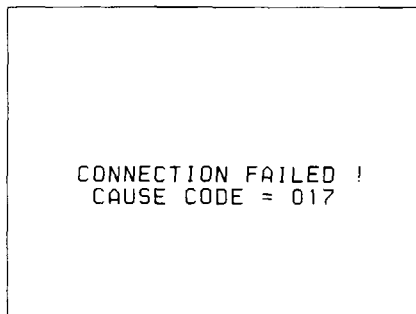

For details on the ISDN cause code, see "ISDN cause codes" on page A-7 (EN).

To return to the main menu

Move the cursor to <EXIT> and press ENTER. The main menu appears.

To connect to an unregistered remote site

- 1 If the DIAL LIST menu is displayed, select <EXIT> to display the main menu. If you have disabled the main menu, the following screen is displayed when you select <EXIT>. Proceed with the process from this screen.

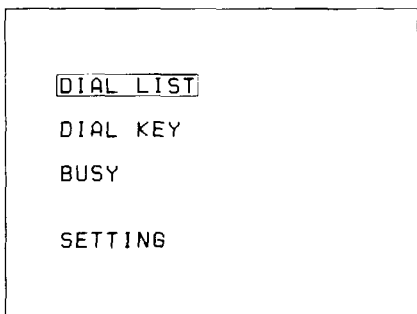

When using the Remote Commander, skip the operation above.

- 2 Select DIAL KEY. When using the Remoter Commander, press DIAL. The following screen appears.

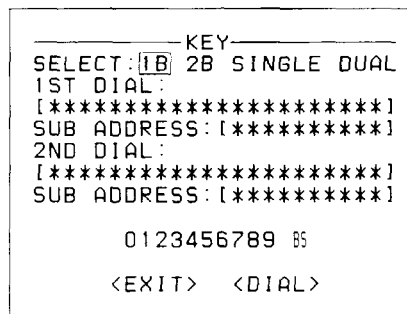

- 3 Select the transmission rate (via an ISDN line from 1B or 2B, via the V.35 interface from SINGLE or DUAL) using ← or →, then press ↓.
- 4 Enter the telephone number for B1-channel of the remote site using ← or →, then press ENTER one by one. When using the Remote Commander, you can enter the number using the number keys. The telephone number is entered in the telephone number box.
 - An asterisk is displayed where nothing is entered.
- 5 Press ↓ and enter the subaddress for B1-channel of the remote site using ← or →, then press ENTER one by one. When using the Remote Commander, you can enter the number using the number keys. The subaddress is entered in the subaddress box.
 - An asterisk is displayed where nothing is entered.
- 6 Press ↓ and repeat steps 4 and 5 to enter the second telephone number and subaddress.
- 7 After entering the subaddress for the second telephone number, move the cursor to <DIAL> using ↓, then press ENTER.

When the remote site is connected, the picture from the remote site is displayed.

Note

The subaddress function may not be worked properly depending on types of switchboards.

Making the Line Busy Temporarily

You can temporarily disable the line so that when a remote site calls, the system does not accept the call.

Select LOCAL BUSY from the main menu.
The following screen appears and the line is disabled.

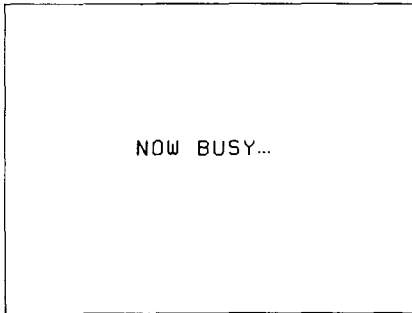

To enable the line

Press any key on the Video Transmitter or Remote Commander.
If you are using the tablet (WACOM ArtPad II for Windows, not supplied), select **ENTER** on the tablet.

The initial setting screen appears and soon the DIAL LIST menu appears.

Notes

- The settings except for the items in the SETTING menu are reset to the original setting.
- This function may not work properly depending on types of switchboards.

Disconnecting the Line

- 1 Select DIAL DISC from the main menu.
The following screen appears.

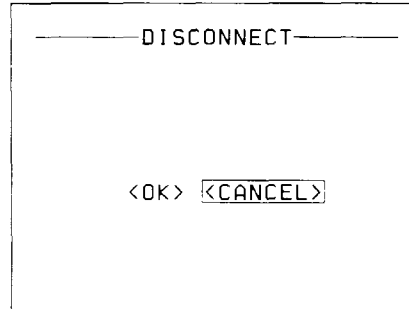

- 2 Select <OK> using **➔**, then press ENTER.
The line disconnects.

To cancel the operation

Move the cursor to <CANCEL> and press ENTER.
The operation is canceled and the main menu appears.

To disconnect the line with the Remote Commander

Press the DISCONNECT keys simultaneously.

Changing the Audio Level and Microphone Input Level

Level

You can change the headset volume and the microphone input level out of two settings or mute the sound.

For details on 12. AUDIO MIC LEVEL, see "Adjusting Line (Headset) Audio Level and Microphone Input Level" on page 2-7 (EN).

Changing the Headset and Line Volume of the Local Site

- 1 Select LOCAL HEADSET from the main menu. The current volume setting is displayed in the lower-left corner of the main menu.

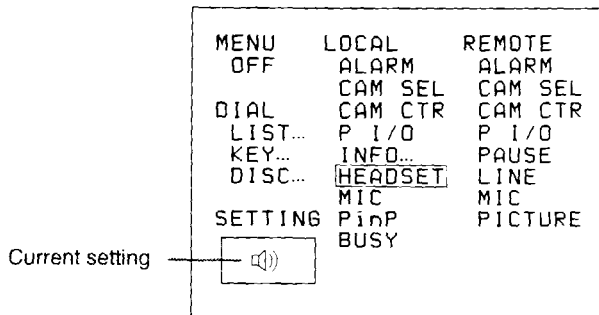

- 2 Press ENTER. Each time you press ENTER, the volume setting is changed as follows.



- [Speaker icon] : The volume is set to the HIGH position level set in 12. AUDIO MIC LEVEL.
- [Speaker icon] : The volume is set to the LOW position level set in 12. AUDIO MIC LEVEL.
- OFF: Sound is muted.

Notes

- The headset sound is monaural.
- If you set AUDIO to OFF in the 12. AUDIO MIC LEVEL setting, no sound is output depending on whether you select [Speaker icon] or [Speaker icon].

Changing the Headset and Line Volume of the Remote Site

- 1 Select REMOTE LINE from the main menu. The current volume setting is displayed in the lower-left corner of the main menu.

- 2 Press ENTER. Each time you press ENTER, the volume setting is changed as follows.



- [Speaker icon] : The volume is set to the HIGH position level set in 12. AUDIO MIC LEVEL.
- [Speaker icon] : The volume is set to the LOW position level set in 12. AUDIO MIC LEVEL.
- OFF: Sound is muted.

Changing the Input Level of the Microphone of the Local Site

- 1 Select LOCAL MIC from the main menu. The current input level setting is displayed in the lower-left corner of the main menu.
- 2 Press ENTER. Each time you press ENTER, the input level setting is changed as follows.

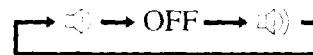

- [Speaker icon] : The input level is set to the HIGH position level set in 12. AUDIO MIC LEVEL.
- [Speaker icon] : The input level is set to the LOW position level set in 12. AUDIO MIC LEVEL.
- OFF: No sound is input.

Changing the Input Level of the Microphone of the Remote Site

- 1 Select REMOTE MIC from the main menu. The current input level setting is displayed in the lower-left corner of the main menu.
- 2 Press ENTER. Each time you press ENTER, the input level setting is changed as follows.

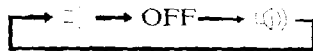

- [Speaker icon] : The input level is set to the HIGH position level set in 12. AUDIO MIC LEVEL.
- [Speaker icon] : The input level is set to the LOW position level set in 12. AUDIO MIC LEVEL.
- OFF: No sound is input.

Selecting the Picture

can select which pictures are displayed from the cameras connected to the VIDEO IN (1 – 8) connectors or EXT VIDEO IN (9 – 256) connectors. You can select the picture from either the local site or remote site.

Switching the Pictures

To select a picture at the local site, select LOCAL CAM SEL from the main menu.

To select a picture at a remote site, select REMOTE CAM SEL.

The following screen appears. (The illustration below is for selecting LOCAL CAM SEL.)

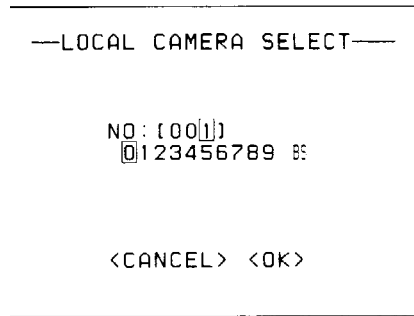

Select the camera number you want to display on the monitor using **←** or **→**, then press ENTER one by one.

The selected camera number is entered in the number box.

Move the cursor to **<OK>** using **↓**, then press ENTER.

The picture of the selected camera is displayed.



cannot select a number greater than the total camera number set in the 8. CAMERA setting.

Switch the pictures with the Remote Commander

Press the CAMERA key and select the camera number with the number keys.

Stopping the Camera Auto Scan Temporarily

You can stop the camera auto scan temporarily.

For details on the camera auto scan, see "Switching Pictures Automatically" on page 2-14 (EN).

- 1 Select REMOTE PAUSE from the main menu. The current setting is displayed in the lower-left corner of the main menu.
- 2 Press ENTER. Each time you press ENTER, the setting is changed between ON and OFF.

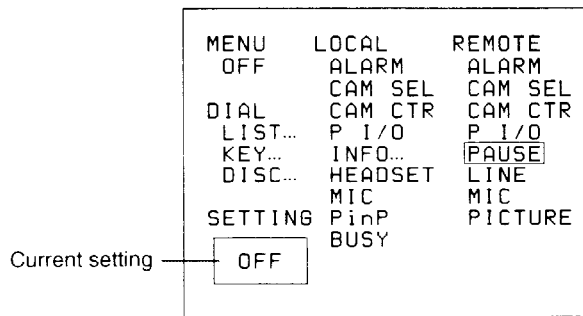

ON: Disable camera auto scan.

OFF: Enable camera auto scan.

Adjusting the Picture

You can adjust a picture (zoom, pan, tilt, focus and iris) or change the picture quality.

Operating the Camera

You can operate the camera with the camera controller.

- 1 To operate a camera at the local site, select LOCAL CAM CTR from the main menu. To operate a camera at a remote site, select REMOTE CAM CTR from the main menu. The following screen appears. (The illustration below is for selecting LOCAL CAM CTR.)

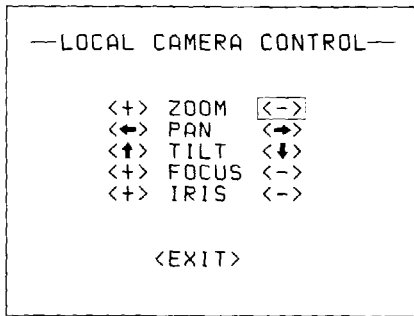

- 2 Select an item to set using ←, ↑, ↓, or →. Press ENTER repeatedly to adjust the item. The picture on the monitor is adjusted.
- 3 Move the cursor to <EXIT> using ↓, then press ENTER. The main menu appears.

To adjust the zoom

Select <+> or <-> next to ZOOM.

To adjust the angle

Select <←> or <→> next to PAN or select <↑> or <↓> next to TILT for the desired angle.

To adjust the focus

Select <+> or <-> next to FOCUS.

To adjust the iris

Select <+> or <-> next to IRIS.

Changing the Quality of the Picture Sent from a Remote Site

You can change the quality of the picture sent from a remote site.

- 1 Select REMOTE PICTURE from the main menu. The current picture quality setting is displayed in the lower-left corner of the main menu.

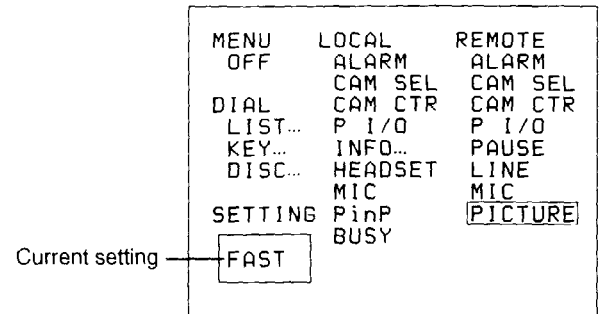

- 2 Press ENTER. Each time you press ENTER, the picture quality setting is changed as follows.

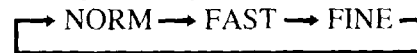

FINE: Gives picture quality preference than picture motion.

NORM: Middle setting between FINE and FAST.

FAST: Gives picture motion preference than picture quality.

Changing the Screen Setting

You can display an inset window or character information on the monitor.

Changing the Position of the Inset Window (Picture-in-Picture)

Normally, the monitor displays the picture sent from a remote site. You can display the picture sent from the local site to a remote site in an inset window.

- 1 Select LOCAL PinP from the main menu. The current position setting is displayed in the lower-left corner of the main menu.

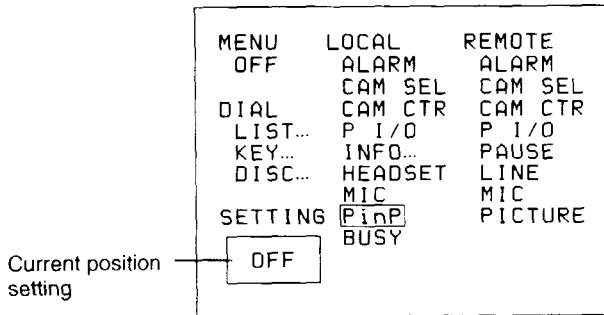

- 2 Press ENTER. Each time you press ENTER, the inset window setting is changed as follows.



- : The inset window is displayed in the upper-right corner.
- : The inset window is displayed in the lower-right corner.
- : The inset window is displayed in the lower-left corner.
- : The inset window is displayed in the upper-left corner.
- OFF:** The inset window is not displayed.

Note

The local site picture displayed in the inset window is a mirrored image.

Selecting the Information to Display on the Monitor

You can superimpose the following information on the on-line monitor.

- 1 Select LOCAL INFO from the main menu. The following screen appears.

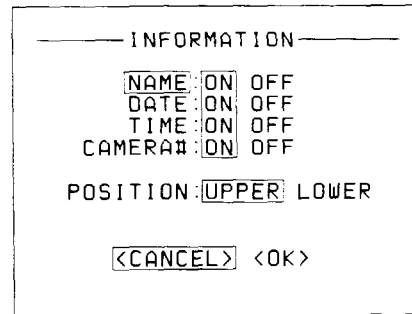

- 2 Select ON or OFF using ←, ↑, → or ↓, then press ↓. The cursor moves down to the next line.
- 3 After setting all items, move the cursor to <OK> using ↓.
- 4 Press ENTER. The information display is set and the main menu appears.

To display the site name

Select ON next to NAME.

To display the date

Select ON next to DATE.

To display the time

Select ON next to TIME.

To display a camera number

Select ON next to CAMERA #.

To select the position to display the information

Select UPPER or LOWER next to POSITION.

Setting Ports

You can check alarm signals and log files in list view. You can also set the bit value of the RELAY OUT port.

Checking the Alarm Signals and Log File of the ALARM IN Port

The following describes how to check the ALARM IN port status.

To check the alarm signal list

- 1 To check the local site's alarm signal to the ALARM IN port, select LOCAL ALARM from the main menu.
To check the remote site's alarm signal to the ALARM IN port, select REMOTE ALARM from the main menu.
The following screen appears. (The illustration below is for selecting LOCAL ALARM.)

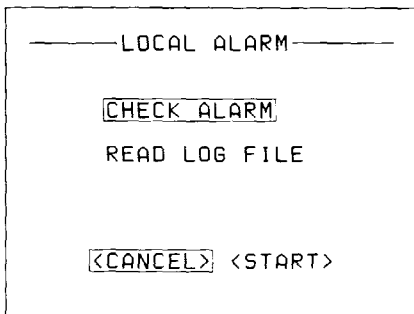

- 2 Move the cursor to <START> using \blacktriangleright , then press ENTER.
The system starts to check the ALARM IN port.



If an alarm has generated, the alarm signal list is displayed.

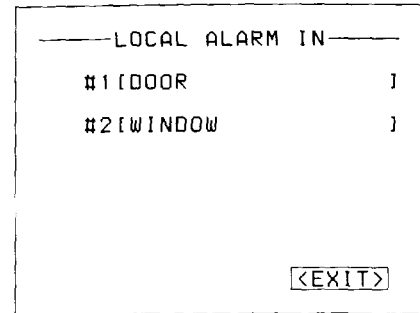

To move from page to page on the ALARM IN list

Move the cursor to $\langle \updownarrow \rangle$ using \blacktriangleleft or \blacktriangleright , then press ENTER. Each time you press ENTER, the next alarm signal list is displayed.
Move the cursor to $\langle \updownarrow \rangle$ using \blacktriangleleft or \blacktriangleright , then press ENTER. Each time you press ENTER, the previous alarm signal list is displayed.

To return to the main menu

Move the cursor to <EXIT> and press ENTER. The main menu appears.

To check the ALARM IN port log file list

You can check the log file list on the ALARM IN port. Up to 128 log data items are stored in the list. If the list is full, the oldest log is deleted when a new one is entered.

- 1 To check the local site's log file list on the ALARM IN port, select LOCAL ALARM from the main menu.
To check the remote site's log file list on the ALARM IN port, select REMOTE ALARM from the main menu.
The following screen appears. (The illustration below is for selecting LOCAL ALARM.)
- 2 Move the cursor to READ LOG FILE using \blacktriangledown , then press ENTER.

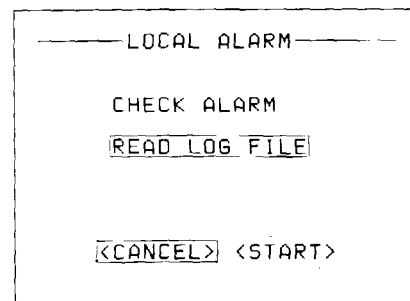

- 3 Move the cursor to <START> using \rightarrow , then press ENTER.

The log file is read.

```

NOW READING LOG FILE...
  
```

The log file list is displayed.

```

—LOCAL ALARM LOG FILE—
1.96/01/03 14:32:19
  #1[ALARM1 ]
2.96/01/04 01:55:54
  #1[ALARM1 ]
3.96/01/05 01:00:57
  #1[ALARM1 ]
4.96/01/06 01:00:45
  #1[ALARM1 ]
5.96/01/07 01:00:43
  #1[ALARM1 ]
<↓> <↑> <EXIT>
  
```

To move from page to page on the ALARM LOG FILE list

Move the cursor to <↓> using \leftarrow or \rightarrow , then press ENTER. Each time you press ENTER, the next alarm log file list is displayed.

Move the cursor to <↑> using \leftarrow or \rightarrow , then press ENTER. Each time you press ENTER, the previous alarm log file list is displayed.

To return to the main menu

Move the cursor to <EXIT> and press ENTER. The main menu appears.

Setting the Bit Value of the RELAY OUT Port

- 1 To set the bit value of the local site's RELAY OUT port, select LOCAL P I/O from the main menu.
To set the bit value of the remote site's RELAY OUT port, select REMOTE P I/O from the main menu.
The following screen appears. (The illustration below is for selecting LOCAL P I/O.)

```

—LOCAL P I/O CONTROL—
#1:0 0
#2:0 0
#3:0 0
#4:0 0
#5:0 0
#6:0 0
#7:0 0
#8:0 0
<EXIT> <OK>
  
```

- 2 Select the port number using \uparrow or \downarrow .
- 3 Move the cursor to the bit column using \leftarrow or \rightarrow , then press ENTER.
Each time you press ENTER, the bit setting is changed cyclically between 0 and 1.
- 4 After setting the bit value, move the cursor to <EXIT> using \downarrow , then press ENTER.
The setting is registered and the main menu appears.

Note

You cannot change the setting of the RELAY OUT port which has been set to IN (That is set in 22.PARALLEL I/O in the SETTING menu.)

For details on 22.PARALLEL I/O, see "Setting Up the RELAY OUT Port" on page 2-11 (EN).

Tablet Operation

Preparing the Tablet

You can operate the menus from the tablet (WACOM, ArtPad II for Windows, not supplied).

Connecting the Tablet

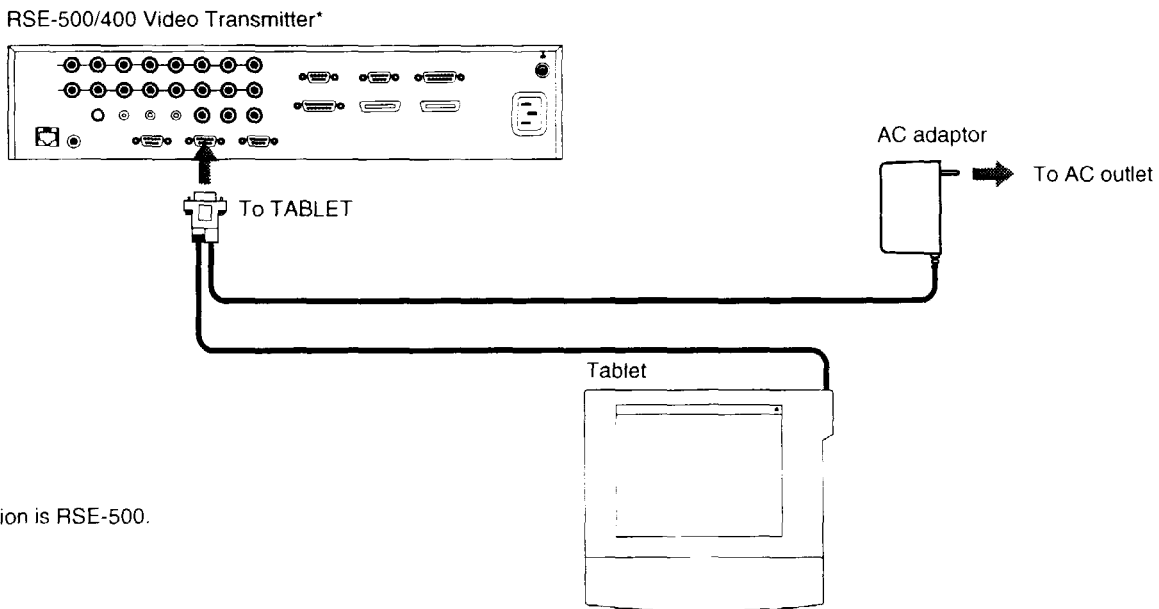

* The illustration is RSE-500.

Connecting the tablet

Note

The tablet does not function if it is connected when the Video Transmitter power is turned on. Connect the tablet and first turn on the tablet power before turning on the power of the Video Transmitter.

Preparing the Tablet

Pasting the Menu Sheet on the Tablet

Peel off the seal from the supplied menu sheet and paste it on the tablet.

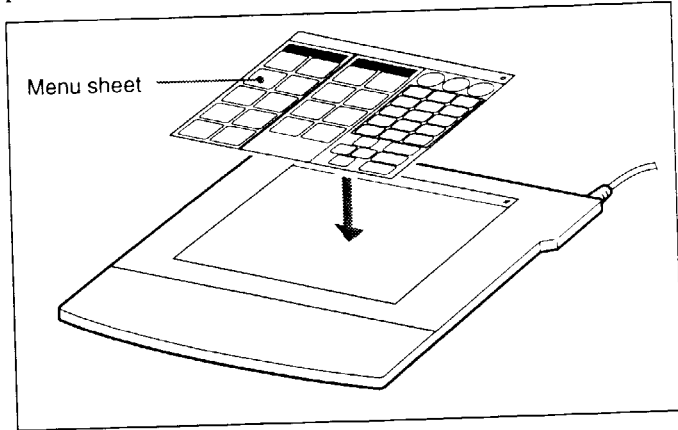

Operating Menus From the Tablet

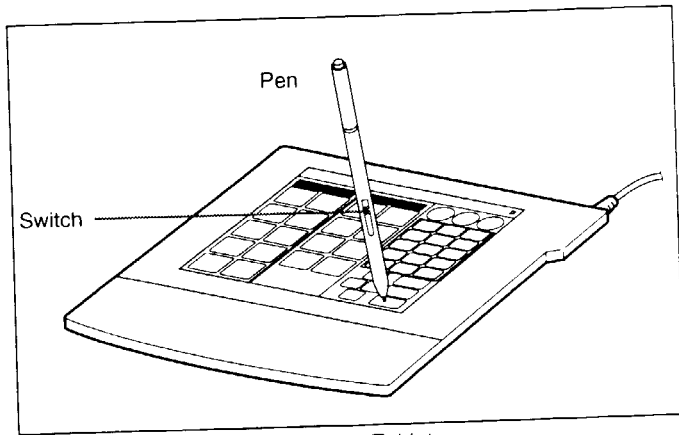

Using the Tablet

To select an item and setting

Press the tablet icon with the pen or press the pen switch when the item or setting becomes highlighted.
For details on tablet operation, see the *Operating Instructions of the Tablet*.

Notes

- If you are not using the pen, place it in the pen stand.
- Do not use the keys on the main unit, the tablet and the Remote Commander at the same time. If you use them simultaneously, the Video Transmitter may not function properly.

Tablet Icons

The menu operations are the same as the operations from the main unit.
For details, see the appropriate page for a particular operation.

Icons on the right side of the menu sheet



Disconnects the line (Hung-up.)
For details, see "Disconnecting the Line" on page 3-3 (EN).



Connects to a remote site that is not registered (Dial.)
For details, see "To connect to an unregistered remote site" on page 3-2 (EN).



Connects to a registered remote site.
For details, see "To connect to a registered remote site" on page 3-1 (EN).



Enters numbers (e.g., telephone number.)
1 and 3 icons are also used to adjust the zoom.
4 and 6 icons are also used to adjust the focus.
7 and 9 icons are also used to adjust the iris.

For details on camera operation, see "Operating the Camera" on page 3-6 (EN).



Deletes the last character (Back space.)



Switches the menu page. switches to the previous page. switches to the next page.

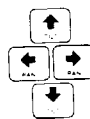

Same as the cursor keys on the Video Transmitter. These keys also control the camera controller. The camera angle moves in the selected direction.
For details, see "Operating the Camera" on page 3-6 (EN).



Selects <OK> on the monitor screen.

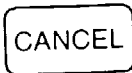

Selects <CANCEL> on the monitor screen.



Same as the ENTER key on the Video Transmitter and enter key on the Remote

CAL site icons



Each time you select ENTER, the headset or line volume setting of the local site is changed.

For details, see "Changing the Headset and Line Volume of the Local Site" on page 3-4 (EN).



Each time you select ENTER, the microphone input level setting of the local site is changed.

For details, see "Changing the Input Level of the Microphone of the Local Site" on page 3-4 (EN).



Each time you select ENTER, the inset window setting is changed.

For details, see "Changing the Position of the Inset Window (Picture-in-Picture)" on page 3-7 (EN).



Makes the line busy temporarily.

For details, see "Making the Line Busy Temporarily" on page 3-3 (EN).



Displays the SETTING menu.

For details, see "Selecting an Item in the SETTING Menu" on page 2-2 (EN).



Checks the alarm signals and log file of the local ALARM IN port.

For details, see "Checking the Alarm Signals and Log File of the ALARM IN Port" on page 3-8 (EN).



Switches the pictures of the local site.

For details, see "Switching the Pictures" on page 3-5 (EN).



Operates a local site camera.

1 3 Adjust the zoom.

4 6 Adjust the focus.

7 9 Adjust the iris.



Move the camera angle in the selected direction.

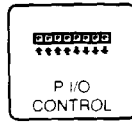

Sets the bit value of the local RELAY OUT port.

For details, see "Setting the Bit Value of the RELAY OUT Port" on the page 3-9 (EN).

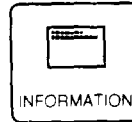

Selects the information to display or not.

For details, see "Selecting the Information to Display on the Monitor" on page 3-7 (EN).

REMOTE site icons

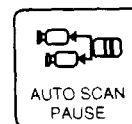

Disables camera auto scan temporarily.

For details, see "Stopping the Camera Auto Scan Temporarily" on page 3-5 (EN).

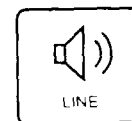

Each time you select ENTER, the line or headset volume setting is changed.

For details, see "Changing the Headset and Line Volume of the Remote Site" on page 3-4 (EN).



Each time you press ENTER, the microphone input level setting is changed.

For details, see "Changing the Input Level of the Microphone of the Remote Site" on page 3-4 (EN).

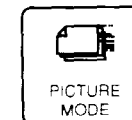

Each time you select ENTER, the picture quality setting is changed.

For details, see "Changing the Quality of the Picture Sent from a Remote Site" on page 3-6 (EN).



Checks the alarm signals and log file of the remote ALARM IN port.

For details, see "Checking the Alarm Signals and Log File of the ALARM IN Port" on page 3-8 (EN).

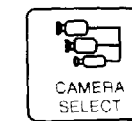

Switches the pictures of the remote site.

For details, see "Switching the Pictures" on page 3-5 (EN).



Operates a remote site camera.

The operation is the same as the operation described for the CAMERA CONTROL icon of LOCAL position.

For details, see "Operating the Camera" on page 3-6 (EN).

Tablet Icons

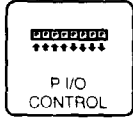

Sets the bit value of the remote RELAY OUT port.

For details, see "Setting the Bit Value of the RELAY OUT Port" on the page 3-9 (EN).



Appendix

Location and Function of Controls

Video Transmitter

Front (RSE-500/400)

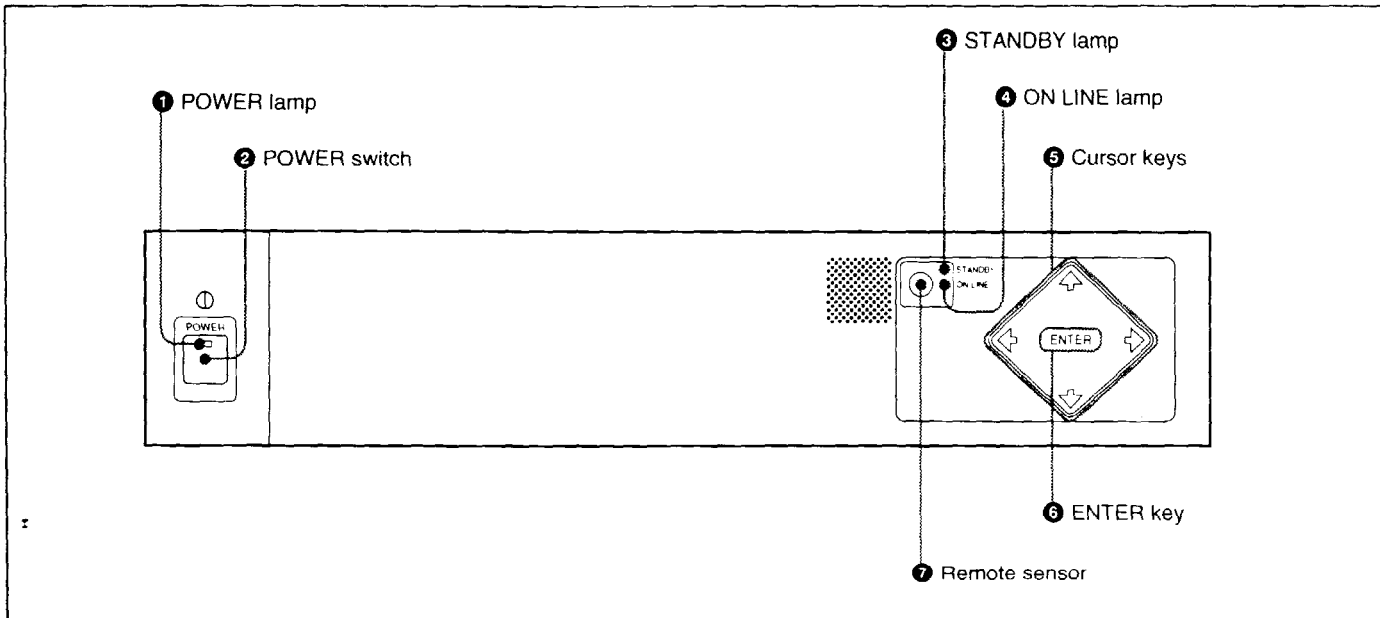

Front of Video Transmitter

1 POWER lamp

Lights up green when the Video Transmitter is turned on by pressing the POWER switch 2.

2 POWER switch

Turns on the Video Transmitter.

3 STANDBY lamp

Lights up red when the Video Transmitter is in the standby mode.

4 ON LINE lamp

Lights up green when a remote site is connected.

Location and Function of Controls

5 Cursor keys (←, ↑, →, ↓)

Press these keys to move the cursor.

6 ENTER key

Press this key to confirm the operation.

7 Remote sensor

Point the Key Commander or Remote Commander (not supplied) at this sensor.

Rear

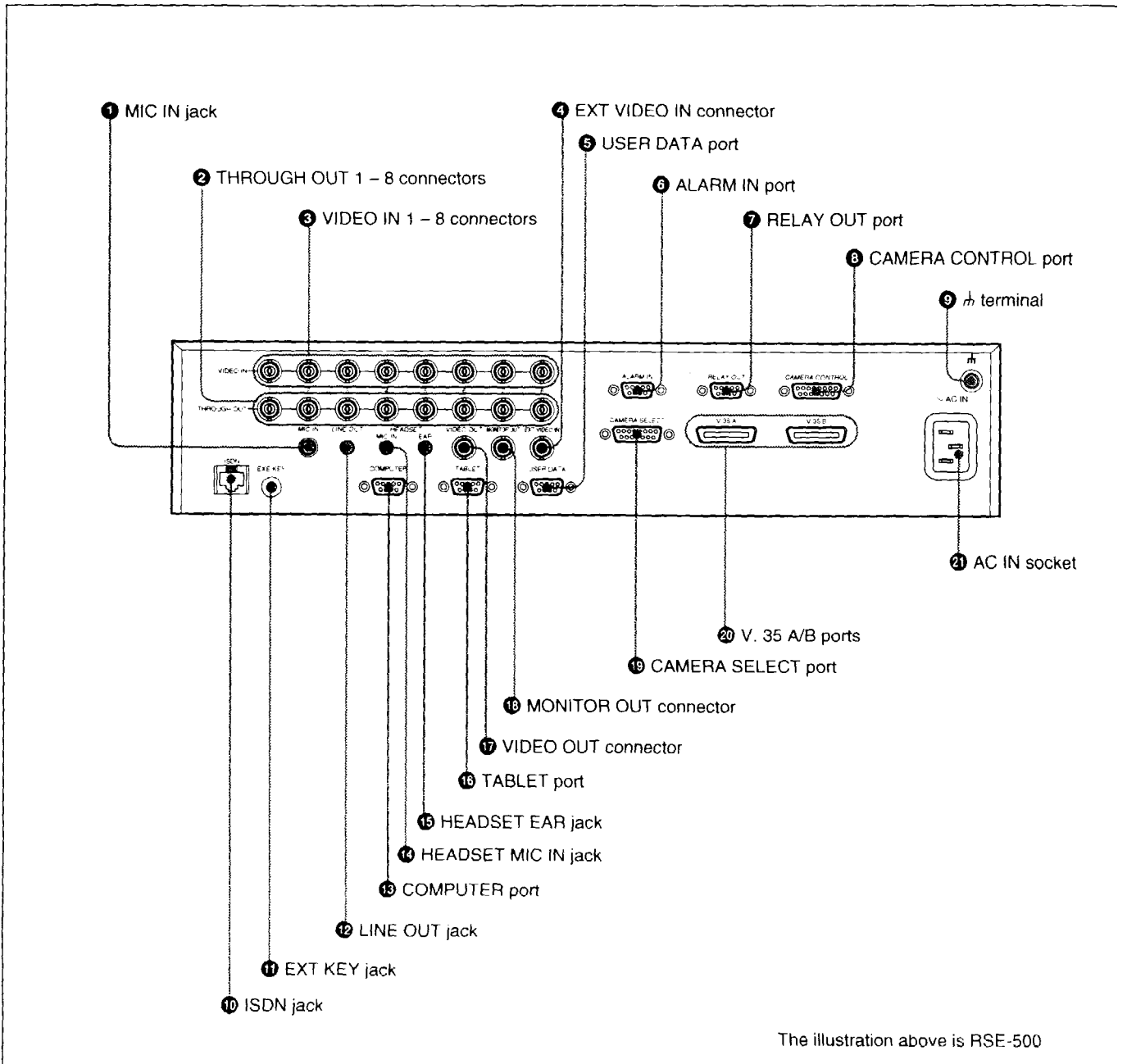

The illustration above is RSE-500

Rear of Video Transmitter

1 MIC IN jack (4 pin, female)

Connect the microphone.

2 THROUGH OUT 1 – 8 connectors (BNC-type)

Outputs the video signal input from the VIDEO IN 1 – 8 connectors.

3 VIDEO IN 1 – 8 connectors (BNC-type)

Connect the video equipment.

4 EXT VIDEO IN connector (BNC-type)

Connect the camera switcher.

Inputs the video signal of a camera (9 – 256) connected to the camera switcher.

5 USER DATA port (D-sub 9-pin, male)

Connect another device which has the RS-232C port for data transmission. (DTE standards)

This port can be set to the RS-232C or the RS-485 interface. When you set this port to the RS-485 interface, you cannot use this port.

This port is set to the RS-232C interface at the factory setting.

6 ALARM IN port (D-sub 9-pin, male)

Connect the alarm generator. An alarm signal is input to this port.

7 RELAY OUT port (D-sub 9-pin, male)

This port is set to INPUT for RSE-500 and to OUTPUT for RSE-400 at the factory.

8 CAMERA CONTROL port (D-sub 15-pin, male)

Connect the camera controller.

This port is set to INPUT for RSE-500 and to OUTPUT for RSE-400 at the factory.

9 ♂ (ground) terminal

Connect to ground line.

10 ISDN jack (8-pin modular)

Connect to the ISDN line with the supplied ISDN modular cable.

11 EXT KEY jack (minijack)

Connects the RM-R500 Remote Commander or RM-J10 Remote Control Receiver (not supplied).

12 LINE OUT jack (pin jack)

Outputs audio signal input from the MIC IN jack.

13 COMPUTER port (D-sub 9-pin, male)

Connect another device which has the RS-232C port for data transmission. (DTE standards)

This port is set to the RS-232C interface at the factory.

14 HEADSET MIC IN jack (minijack)

Connect the microphone miniplug of the headset.

15 HEADSET EAR jack (minijack)

Connect the headphones miniplug of the headset.

16 TABLET port (D-sub 9-pin, male)

Connect the tablet (WACOM Art Pad II for Windows, not supplied.) This port is set to the RS-232C interface at the factory.

17 VIDEO OUT connector (BNC-type) (only for RSE-500)

Connect the monitor for menu operations.

18 MONITOR OUT connector (BNC-type)

Connect the monitor for monitoring the picture input from the VIDEO IN 1 – 8 or the EXT VIDEO IN connector.

19 CAMERA SELECT port (D-sub 15-pin, male)

Connect the camera switcher to switch the picture of cameras connected to the camera switcher.

20 V. 35 A/B ports (half-pitch 36-pin)

Connect to the terminal adaptor with the V.35 cable (not supplied.)

21 AC IN (inlet) socket

Connect to an AC outlet with the supplied AC power cord.

Remote Commander (RM-R500) (Supplied With RSE-500 Only)

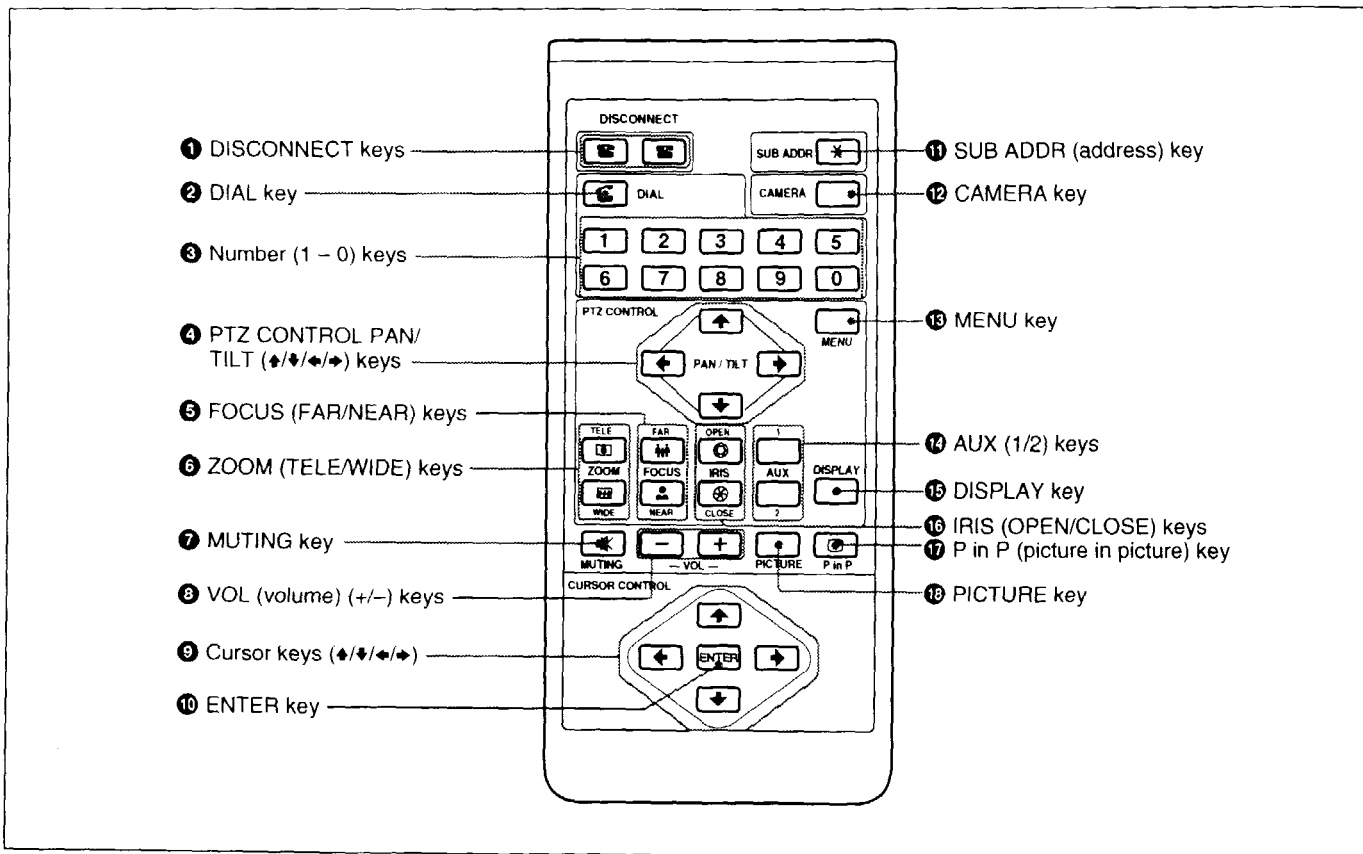

1 DISCONNECT keys

Press these two keys simultaneously to disconnect the line.

2 DIAL key

Press this key to call the remote party, the KEY menu appears. (See page 3-2 (EN))

3 Number (1 - 0) keys

Press this key to input numbers such as telephone numbers and subaddresses.

4 PTZ CONTROL PAN/TILT (↑/↓/←/→) keys

These keys adjust the camera angle.

← key functions as BS (back space) key when adjusting the SETTING menu during off line.

5 FOCUS (FAR/NEAR) keys

These keys control the focus of the camera.

FAR: press to focus the picture further away.

NEAR: press to focus the picture closer.

6 ZOOM (TELE/WIDE) keys

These keys control the zoom of the camera.

TELE: press to zoom in the picture.

WIDE: press to zoom out the picture.

7 MUTING key

This key mutes the sounds of the local party. Press again to cancel the muting.

8 VOL (volume) (+/-) keys

These keys adjust the volume of the remote party.

+: press to increase the volume.

-: press to decrease the volume.

9 Cursor keys (↑/↓/←/→)

These keys move the cursor on the monitor screen to the desired position.

Holding a key down keeps the cursor moving in the direction of the key selected. To move the cursor one increment only, press once.

If you press the ← key during the connection process, the connection is canceled.

10 ENTER key

This key functions the same as the ENTER key of the unit

Transmitting Data

11 SUB ADDR (address) key

This key is for future use.

12 CAMERA key

Press this key to select the camera. For setting the camera number, use the number keys 3.

13 MENU key

Press this key to bring up the main menu on the monitor screen.

14 AUX (1/2) keys

Press these keys to recall preset camera angles and zoom settings.

1: press to recall settings registered in 1.

2: press to recall settings registered in 2.

15 DISPLAY key

Press this key to set the on-screen display. Each time you press this key, the screen switches between ON and OFF.

16 IRIS (OPEN/CLOSE) keys

These keys control the iris of the camera.

OPEN: press to open the iris.

CLOSE: press to close the iris.

17 P in P (picture in picture) key

This key displays an inset window on the monitor screen. Each time you press the key, the inset window moves as follows.

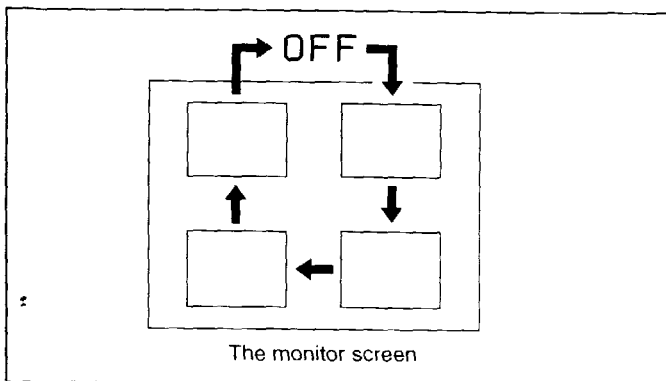

18 PICTURE key

This key changes the quality of the picture. Each time you press the key, the quality of the picture changes cyclically among FINE, NORM and FAST.

You can transmit data from a device connected to the USER DATA port between Video Transmitters via ISDN.

Connecting a Device to the USER DATA Port

Connect the RS-232C port of the device and the USER DATA port of the Video Transmitter with the RS-232C cable.

Use an appropriate RS-232C cable that complies with the USER DATA port standards.

For details on pin assignment of the USER DATA port, see "Pin Assignment" on page A-10 (EN).

Data Transmission Format

The data transmission format is as follows:

Baud rate: 1200/4800/9600/19200 bps

Data word length: 7/8 bits

Parity bits: none/odd/even

Stop bits: 1/1.5/2 bits

For details, see "Setting Up the USER DATA Port" on page 2-13 (EN).

Troubleshooting

If the Video Transmitter system does not function or functions incorrectly, check the following

Cause and Remedy

Symptom	Cause	Remedy
The main menu is not displayed.	The Video Transmitter is not turned on.	Press the POWER switch. (page 1-6 (EN))
	The Remote Commander batteries are dead.	Replace the batteries. (page 1-6 (EN))
	The Video Transmitter and monitor are not connected properly.	Check the connection. (pages 1-4 (EN), 1-5 (EN))
	The monitor is not turned on.	Turn on the monitor.
	The main menu is not set to display.	Set 20. MENU to ON in the SETTING menu. (page 2-9 (EN))
	The Video Transmitter is in the standby mode.	Press any key on the Video Transmitter or Remote Commander. Select any location on the tablet.
No sound or little sound	Volume setting is too low.	Adjust the volume in 12. AUDIO MIC LEVEL in the SETTING menu (page 2-7 (EN)).
	Volume is disabled.	Set 13. AUDIO-HEADSET to HIGH or LOW in the SETTING menu. (page 2-8 (EN))
	Microphone, headset, or speaker are not connected.	Connect microphone, headset or speaker. (pages 1-4 (EN), 1-5 (EN))
Blurred image	Out of focus.	Adjust the focus in CAM CTR in the main menu (page 3-6 (EN)) Adjust the camera focus.
No picture	The number of cameras connected to the Video Transmitter is not registered.	Register the number of cameras in 8. CAMER in the SETTING menu. (page 2-13 (EN))
	Camera is not connected properly.	Check the connection. (pages 1-4 (EN), 1-5 (EN))
	Camera iris is closed.	Adjust the iris in CAM CTR in the main menu. (page 3-6 (EN)) Adjust the camera iris.
	Camera number is not selected.	Select a camera number in CAM SEL in the main menu. (page 3-5 (EN))
	The picture is switched to a camera number whose signal is not input in the camera auto scan mode.	Cancel the camera auto scan mode. (page 3-4 (EN))
Cannot connect to a remote site.	The line is not connected.	Check the ISDN line connection. (pages 1-4 (EN), 1-5 (EN))
	The telephone number of the remote site is not registered.	Register the telephone number in 5. LIST (NORMAL) in the SETTING menu. (page 2-15 (EN))

ISDN cause codes

If the connection failed via ISDN, the Video Transmitter displays the ISDN cause code which is sent by ISDN network to show you the call status information.

Code	Meaning	Code	Meaning
1	Unallocated (unassigned) number	57	Bearer capability not authorized
2	No route to specified transit network	58	Bearer capability not presently available
3	No route to dest	63	Service or option not available, unspecified
6	Channel unacceptable	65	Bearer capability not implemented
7	Call awarded and being delivered in an established channel	66	Channel type not implemented
16	Normal clearing	69	Requested facility not implemented
17	User busy	70	Only restricted digital information bearer capability is available
18	No user responding	79	Service or option not implemented, unspecified
19	User alerting, no answer	81	Invalid call reference value
20	No reply	82	Identified channel does not exist
21	Call rejected	83	A suspended call exists, but this call identity does not
22	Number Changed	84	Call identity in use
26	Non-selected user clearing	85	No call suspended
27	Destination out of order	86	Call having the requested call identity has been cleared
28	Invalid number format (incomplete address)	88	Incompatible destination
29	Facility rejected	91	Invalid transit network selection
30	Response to STATus ENquiry	95	Invalid message, unspecified
31	Normal, unspecified	96	Mandatory information element is missing
34	Circuit/channel congestion	97	Message type non-exist, or not implemented
38	Network out of order	98	Message not compatible with call state or message type non-existent or not implemented
41	Temporary failure		
42	Switching equipment congestion	99	Information element non-existent or not implemented
43	Access information discarded	100	Invalid information element contents
44	Requested channel not available	101	Message not compatible with call state
47	Resource unavailable, unspecified	102	Recovery of timer expiry
49	Quality of service unavailable	111	Protocol error, unspecified
50	Requested facility not subscribed	127	Interworking, unspecified

Specifications

Video Transmitter

Motion video

Operating bandwidth	56 Kbps/64 Kbps/112 Kbps/128 Kbps
Coding	H.261 (ITU-T recommendation)
Picture elements	CIF 352 pixel × 288 lines
Frame rate	Maximum 15 frames per second
Color system	NTSC (Mutually connectable with PAL system.)

Audio

Bandwidth	3.4 kHz (ITU-T recommendation G.728)
Transfer rate	16 Kbps (ITU-T recommendation G.728)

Network

Multiplexing	Video, audio, data
Frame format	H.221 (ITU-T recommendation)
Interface	ISDN (BRI)

Tablet input

Interface	RS-232C
Baud rate	9600 bps

User data I/O

Interface	RS-232C
Baud rate	1200/4800/9600/19200 bps

Power/General

Power requirements	AC 120 V, 50/60 Hz
Power consumption	0.55 A
Operating temperature	41°F to 94°F (5°C to 35°C)
Operating humidity	20% to 80% (no condensation)
Storage temperature	-4°F to 140°F (-20°C to 60°C)
Storage temperature	20% to 80% (no condensation)
Dimensions	16 3/4 × 3 1/2 × 14 inches (424 × 88 × 356 mm) excluding projecting parts (w/h/d)
Mass	15 lb 7 oz (7.0 kg)
Accessories supplied	Remote Commander (1) (only for RSE-500) Size AA (LR6) alkaline batteries (2) (only for RSE-500) Menu sheet (1) AC power cord (1) Operating Instructions (1)

Design and specifications are subject to change without notice.

Pin Assignment

ISDN jack

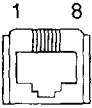

Modular jack

Pin	Acronym	Meaning	Pin	Acronym	Meaning
1	NC	—	5	RB	Receive-
2	NC	—	6	TB	Transmit-
3	TA	Transmit+	7	NC	—
4	RA	Receive+	8	NC	—

CAMERA SELECT port (female)

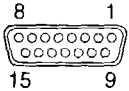

D-sub 15-pin port

Pin	Acronym	Meaning
1	DGND	Digital ground
2	VISEL0	Camera select 0
3	VISEL1	Camera select 1
4	VISEL2	Camera select 2
5	VISEL3	Camera select 3
6	VISEL4	Camera select 4
7	VISEL5	Camera select 5
8	VISEL6	Camera select 6
9	VISEL7	Camera select 7
10	ON LINE	On line
11	ALARM OUT	Alarm out
12	DGND	Digital ground
13	DGND	Digital ground
14	RS-485A	RS-485+
15	RS-485B	RS-485-

COMPUTER port (male)



D-sub 9-pin port

Pin	Acronym	Meaning
1	NC (DCD)	(Data carrier detect)
2	RxD	Receive data
3	TxD	Transmit data
4	DTR	Data terminal ready
5	GND	Ground
6	DSR	Data set ready
7	RTS	Request to send
8	CTS	Clear to send
9	NC	—

Notes

- Pins 4 and 6 have a short-circuit inside the unit.
- Pins 7 and 8 have a short-circuit inside the unit.

TABLET port (male)



D-sub 9-pin port

When setting to the RS-232C interface

Pin	Acronym	Meaning
1	NC (DCD)	(Data carrier detect)
2	RxD	Receive data
3	TxD	Transmit data
4	DTR	Data terminal ready
5	GND	Ground
6	DSR	Data set ready
7	RTS	Request to send
8	CTS	Clear to send
9	NC	—

When setting to the RS-422 interface

Pin	Acronym	Meaning
1	NC	—
2	TB	Transmit +
3	RA	Receive +
4	NC	—
5	GND	Ground
6	NC	—
7	TA	Transmit -
8	RB	Receive -
9	NC	—

Note

Pins 4 and 6 have a short-circuit and pins 7 and 8 are used as a flow control signal when setting to the RS-232C interface.

Specifications

USER DATA port (male)



D-sub 9-pin port

Pin	Acronym	Meaning
1	NC (DCD)	(Data carrier detect)
2	RxD	Receive data
3	TxD	Transmit data
4	DTR	Data terminal ready
5	GND	Ground
6	DSR	Data set ready
7	RTS	Request to send
8	CTS	Clear to send
9	NC	—

Notes

- This port can be used as either the RS-232C or the RS-485 interface. If this is used as the RS-485 interface, pins 14 and 15 of the CAMERA SELECT port are used for the RS-485 interface.
- Pins 4 and 6 have a short-circuit and pins 7 and 8 are used as a flow control signal when setting to the RS-232C interface.

CAMERA CONTROL port (female)

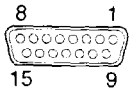

D-sub 15-pin port

Pin	Acronym	Meaning
1	C1	Tilt ↑
2	C2	Tilt ↓
3	C3	Pan →
4	C4	Pan ←
5	C5	Zoom -
6	C6	Zoom +
7	C7	Focus -
8	C8	Focus +
9	C9	Iris -
10	C10	Iris +
11	C11	AUX1
12	C12	AUX2
13	GND	Ground
14	GND	Ground
15	GND	Ground

ALARM IN port (female)



D-sub 9-pin port

Pin	Meaning	Pin	Meaning
1	Port 1	6	Port 6
2	Port 2	7	Port 7
3	Port 3	8	Port 8
4	Port 4	9	Ground
5	Port 5	-	-

RELAY OUT port (female)



D-sub 9-pin port

Pin	Meaning	Pin	Meaning
1	Port 1	6	Port 6
2	Port 2	7	Port 7
3	Port 3	8	Port 8
4	Port 4	9	Ground
5	Port 5	-	-

V.35 (A/B) port (female)

PCS-K32 V.35 adaptor connector cable

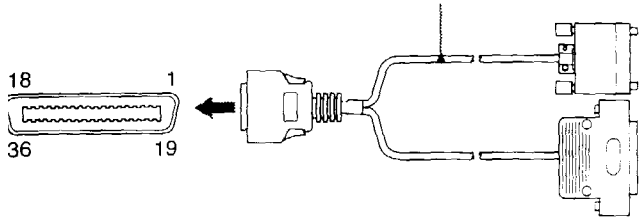

Half-pitch 36-pin port

Pin	Acronym	Meaning	Pin	Acronym	Meaning
1	SGND	Signal ground	19	SGND	Signal ground
2	SGND	Signal ground	20	SGND	Signal ground
3	CABLE1	CABLE1	21	CABLE2	CABLE2
4	V35SD+	Send data+	22	V35RI	Ring Indication
5	V35SD-	Send data-	23	V35DR	Data set ready
6	V35RD+	Receive data+	24	366DLO	Data line occupied
7	V35RD-	Receive data-	25	V35CS	Clear to send
8	V35ER	Data terminal ready	26	366ACR	Abandon call & retry
9	V35RS	Request to send	27	366DPR	Digit present
10	V35ST+	Send Timing+	28	366CRQ	Call request
11	V35ST-	Send Timing-	29	366PND	Present next digit
12	V35RT+	Receive Timing+	30	366NB1	Digit signal 1
13	V35RT-	Receive Timing-	31	366NB2	Digit signal 2
14	V35TT+	Transmit Timing+	32	366NB4	Digit signal 4
15	V35TT-	Transmit Timing-	33	366NB8	Digit signal 8
16	SGND	Signal ground	34	SGND	Signal ground
17	SGND	Signal ground	35	SGND	Signal ground
18	CGND	Chassis ground	36	SGND	Signal ground

CCITT V.35 connector (cable side)

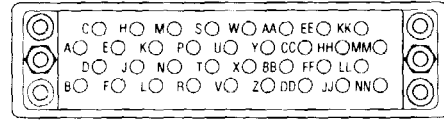

Pin	Signal	Description
A	CGND	Chassis ground
B	SGND	Signal ground
C	V35RS	Request to send
D	V35CS	Clear to send
E	V35DR	Data set ready
H	V35ER	DTE ready
J	V35RI	Ring indicator
P	V35SD+	Send data+
R	V35RD+	Receive data+
S	V35SD-	Send data-
T	V35RD-	Receive data-
U	V35TT+	Transmit timing+
V	V35RT+	Receive timing+
W	V35TT-	Transmit timing-
X	V35RT-	Receive timing-
Y	V35ST+	Send timing+
AA	V35ST-	Send timing-

D-sub 25-pin connector (cable side)

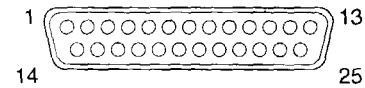

Pin	Signal	Description
1	SGND	Signal ground
2	366DPR	Digit present
3	366ACR	Abandon call & retry
4	366CRQ	Call request
5	366PND	Present next digit
7	SGND	Signal ground
14	366NB1	Digit signal 1
15	366NB2	Digit signal 2
16	366NB4	Digit signal 4
17	366NB8	Digit signal 8
18	SGND	Signal ground
19	SGND	Signal ground
22	366DLO	Data line occupied

Glossary

Codec

An abbreviation for Coder-Decoder. An electronic device that converts an analog signal such as voice or video to a digital data stream, compresses it, and sends it over a digital communications line. Another codec reverses the process at the receiving site.

Compression

A task where a codec compresses data before sending it over a digital communications line.

Interface

A protocol connecting two different devices so that they can communicate with each other.

ISDN

An acronym for Integrated Services Digital Network. This is a communications protocol defined by CCITT on transmission of integrated voice, video, and data. Bandwidths include basic (64 Kbps) and primary rate (1.544 and 2.048 Mbps.)

Menu

A collection of settings shown on the TV monitor which the user can change.

PinP

An abbreviation for Picture-in-Picture. This function allows the user, while keeping the remote scene on the TV monitor, to display the local scene in a smaller window on the same TV monitor.

Subaddress

One ISDN line can support up to 8 devices. Because all these devices share the same line number, subaddresses are applied to them so that each has a unique number.

Zoom

With the camera remaining stationary, by adjusting the zoom lens you can quickly move in or out on an object.

A

- Alarm signal
 - Check the alarm signal list 3-8 (EN)
 - Check the alarm log file list 3-8 (EN)
- Answering mode 2-7 (EN)

B

- Bit
 - Set the bit value of the RELAY OUT port 3-9 (EN)

C

- Camera adjustments
 - Focus adjustment 3-6 (EN)
 - Iris adjustment 3-6 (EN)
 - Pan adjustment 3-6 (EN)
 - Tilt adjustment 3-6 (EN)
 - Zoom adjustment 3-6 (EN)
- Camera auto scan
 - Set camera auto scan 2-14 (EN)
 - Stop camera auto scan temporarily 3-5 (EN)
- Cleaning 6 (EN)
- Codec A-12 (EN)
- Communication
 - Start communication 3-1 (EN)
 - End communication 3-3 (EN)
- Compression A-12 (EN)
- Connection 1-3 (EN)–1-5 (EN)
- Cursor 1-7 (EN)

D

- Data transmission A-5 (EN)
- Debugging 2-18 (EN)
- Diagnostics 2-19 (EN)
- DIAL LIST menu 3-1 (EN)
- Display information 3-7 (EN)

G

- Glossary A-12 (EN)

I

- Icon (on the tablet) 4-2 (EN)
- ID name 2-3 (EN)
- Inserting Batteries 1-6 (EN)
- Inset window
 - Change the position of the inset window 3-7 (EN)
 - Set the inset window 2-10 (EN)
- Interface A-12 (EN)
- ISDN A-12 (EN)

K

- Key sound 2-9 (EN)

L

- LDN (Local Directory Number) 2-4 (EN)
- Line
 - Make the line busy temporarily 3-3 (EN)
- Location and function of controls A-1 (EN)
- Loop back 2-18 (EN)

M

- Main menu
 - Item list 1-8 (EN)
 - Disable the main menu 2-9 (EN)
- Maintenance 2-18 (EN)
- Menu
 - Display the menu 1-7 (EN)
 - Operation 1-7 (EN)
- Menu sheet 4-2 (EN)
- Microphone
 - Change the input level of the local site 3-4 (EN)
 - Change the input level of the remote site 3-4 (EN)
 - Set the microphone input level 2-7 (EN), 2-8 (EN)

P

- Password 2-6 (EN)
- Picture
 - Switch the picture 3-5 (EN)
- Picture quality
 - Change picture quality 3-6 (EN)
 - Set picture quality 2-8 (EN)
- Picture in Picture Function 3-7 (EN)
- Port
 - Pin assignment A-9 (EN)–A-11 (EN)
 - Set up the ports 3-8 (EN), 3-9 (EN)
- Power
 - Connection 1-4 (EN), 1-5 (EN)
 - Turn on the power 1-6 (EN)
 - Turn off the power 1-6 (EN)

R

- Registration
 - Called party 2-15 (EN)
 - Called party when an alarm signal is input 2-16 (EN)
 - Calling party with permission to be connected 2-17 (EN)
- ID name 2-3 (EN)
- Line rate 2-5 (EN)
- Number of cameras 2-13 (EN)
- Password 2-6 (EN)
- Site name 2-3 (EN)
- SPID 2-4 (EN)
- Subaddress 2-3 (EN)
- Telephone number 2-3 (EN)

Remote Commander

- Location and function of controls A-4 (EN)
- Ringer 2-9 (EN)

S

- SETTING menu
 - Item list 2-1 (EN)
 - Operation 2-2 (EN)
- Specification A-8 (EN)
- SPID 2-5 (EN)
- Standby 2-14 (EN)
- Subaddress 2-4 (EN), 2-15 (EN), 2-16 (EN), 3-2 (EN)

T

- Tablet
 - Connection 4-1 (EN)
 - Icon 4-2 (EN)
 - Operation 4-2 (EN)

V

- Version 2-9 (EN)
- Volume
 - Change the volume of the local site 3-4 (EN)
 - Change the volume of the remote site 3-4 (EN)
 - Set the volume 2-7 (EN), 2-8 (EN)